

Planning Permit Application Form

455 County Center, 2nd Floor • Redwood City CA 94063
Mail Drop: PLN 122 • TEL (650) 363-4161 • FAX (650) 363-4849
www.co.sanmateo.ca.us/planning

PLN: 2016-00444

BLD:

Applicant/Owner Information

Applicant: CARLOS ZUBIETA

Mailing Address: 1725-A ABBOT KULISEY BLVD
VENICE CA

Zip: 90291

Phone, W: 310 827-8195

H: 310 880-0417

E-mail Address: carlos.zubieta@gmail.com FAX:

Name of Owner (1): ZUBAN LLC

Mailing Address: 600 MILWOOD AVE
VENICE CA
Zip: 90291

Phone, W: 310 577-1785

H: 310 435-6670

E-mail Address: tatonaveverdego.net

Name of Owner (2):

Mailing Address:

Zip:

Phone, W:

H:

E-mail Address:

Project Information

Project Location (address): 199 ARBOR LANE
MOSS BEACH, CA 94038

Assessor's Parcel Numbers: 037-123-430

Zoning: R-1/s-17/DR/LD

Parcel/lot size:

SF (Square Feet)

List all elements of proposed project: (e.g. access, size and location, primary and accessory structures, well, septic, tank)

NEW SINGLE FAMILY RESIDENCE w/ 2 CAR GARAGE.
Approx 4,163 SF

Describe Existing Site Conditions/Features (e.g. topography, water bodies, vegetation):

SITE HAS NO BUILDINGS.

Describe Existing Structures and/or Development:

N/A

Signatures

We hereby certify that the information stated above and on forms, plans and other materials submitted herewith in support of the application is true and correct to the best of our knowledge. It is our responsibility to inform the County of San Mateo through our assigned project planner of any changes to information represented in these submittals.

Owner's signature:

Owner's signature:

Applicant's signature:

10/13/2016

Application for Design Review by the County Coastsides Design Review Committee

County Government Center ■ 455 County Center ■ Redwood City CA 94063
Mail Drop PLN 122 ■ 650 • 363 • 4161 ■ FAX 650 • 363 • 4849

Permit #: PLN 2016-00444

Other Permit #: _____

Applicant:

Name: CARLOS ZUBIETA

Address: 1725-A ABBOT KINNEY
VENICE, CA Zip: 90291

Phone, W: 310 827-8195 H: 310 880-0417

Email: carlos@cz-a.net

Owner (if different from Applicant):

Name: ZUBAR LLC

Address: 660 MILWOOD AVE
VENICE CA Zip: 90291

Phone, W: 310 577 1785 H: 310 435-6670

Email: tatiana@verdego.net

Architect or Designer (if different from Applicant): SAME

Name: _____

Address: _____ Zip: _____

Phone, W: _____ H: _____ Email: _____

Project location:

APN: 037-123-430

Address: Arbor Lane
Zip: 94038

Zoning: R-1/S-17/DR/CB

Parcel/lot size: _____ sq. ft.

Site Description:

- Vacant Parcel
- Existing Development (Please describe): _____

Project:

- New Single Family Residence: _____ sq. ft
- Addition to Residence: _____ sq. ft
- Other: _____

Additional Permits Required:

- Certificate of Compliance Type A or Type B
- Coastal Development Permit
- Fence Height Exception (not permitted on coast)
- Grading Permit or Exemption
- Home Improvement Exception
- Non-Conforming Use Permit
- Off-Street Parking Exception
- Variance

Describe Project:

Check if matches existing

Fill in Blanks:

Material

Color/Finish

(If different from existing, attach sample)

| | | | |
|------------------------|----------------------------|-------|--------------------------|
| a. Exterior walls | WESTERN RED CEDAR / STUCCO | _____ | <input type="checkbox"/> |
| b. Trim | ZINC COATED METAL | _____ | <input type="checkbox"/> |
| c. Windows | ALUMINIUM ANODIZED | _____ | <input type="checkbox"/> |
| d. Doors | ALUMINIUM ANODIZED | _____ | <input type="checkbox"/> |
| e. Roof | BUILT UP WITH ROCK | _____ | <input type="checkbox"/> |
| f. Chimneys | N/A | _____ | <input type="checkbox"/> |
| g. Decks & railings | WOOD / CONCRETE | _____ | <input type="checkbox"/> |
| h. Stairs | N/A | _____ | <input type="checkbox"/> |
| i. Retaining walls | N/A | _____ | <input type="checkbox"/> |
| j. Fences | N/A | _____ | <input type="checkbox"/> |
| k. Accessory buildings | N/A | _____ | <input type="checkbox"/> |
| l. Garage/Carport | WESTERN RED CEDAR / STUCCO | _____ | <input type="checkbox"/> |

To approve this application, the County must determine that this project complies with all applicable regulations including the required findings that the project does conform to the standards and guidelines for design review applicable to the location of the project pursuant to Section 6565.10.

(optional) Applicant's Statement of project compliance with standards and guidelines (check if attached).

I hereby certify that the information stated above and on forms, plans, and other materials submitted herewith in support of the application is true and correct to the best of my knowledge. It is my responsibility to inform the County of San Mateo through my assigned project planner of any changes to information represented in these submittals.

Owner: 

Applicant: _____

Date: 10/13/16

Date: _____

Environmental Information Disclosure Form

PLN 2016-0044
 BLD _____

Project Address:
199 ARBOR LAKE
MOSS BEACH, CA 94038
 Assessor's Parcel No.: 037 - 123 - 430
 Zoning District: R-1/S-17/DR/CD

Name of Owner: ZUBAN LLC
 Address: 660 MILWOOD AVE
VENICE CA Phone: 310 435-6670
 Name of Applicant: CARLOS ZUBIETA
 Address: 1725-A ABBOT KINNEY BLVD
VENICE, CA 90291 Phone: 310 877-8195

Existing Site Conditions

Parcel size: 14,320 SF

Describe the extent and type of all existing development and uses on the project parcel, including the existence and purpose of any easements on the parcel, and a description of any natural features on the project parcel (i.e. steep terrain, creeks, vegetation).

NO EXISTING STRUCTURE ON SITE, EXISTING UTILITY EASEMENT @ FRONT OF LOT, DEAN CREEK ALONG SOUTH EDGE OF PROPERTY, PACIFIC OCEAN TO THE WEST

Environmental Review Checklist

1. California Environmental Quality Act (CEQA) Review

| Yes | No | Will this project involve: |
|-------------------------------------|-------------------------------------|--|
| | | a. Addition to an existing structure > 50% of the existing area OR > 2,500 sq. ft? |
| | <input checked="" type="checkbox"/> | b. Construction of a new multi-family residential structure having 5 or more units? |
| | <input checked="" type="checkbox"/> | c. Construction of a commercial structure > 2,500 sq.ft? |
| <input checked="" type="checkbox"/> | | d. Removal of mature tree(s) (≥ 6" d.b.h. in Emerald Lake Hills area or ≥ 12" d.b.h. in any residential zoning district)? If yes, how many trees to be removed? <u>2</u> |
| <input checked="" type="checkbox"/> | | e. Land clearing or grading? If yes, please state amount in cubic yards (c.y.): Excavation: <u>50</u> c.y. Fill: _____ c.y. |
| | <input checked="" type="checkbox"/> | f. Subdivision of land into 5 or more parcels? |
| <input checked="" type="checkbox"/> | | g. Construction within a State or County scenic corridor? |
| | <input checked="" type="checkbox"/> | h. Construction within a sensitive habitat? |
| | <input checked="" type="checkbox"/> | i. Construction within a hazard area (i.e. seismic fault, landslide, flood)? |
| | <input checked="" type="checkbox"/> | j. Construction on a hazardous waste site (check with Co. Env. Health Division)? |

Please explain all "Yes" answers:

REMOVAL OF TREES @ BUILDING PAD LOCATIONS, MINIMAL GRADING, SCENIC CORRIDORS RESPECTIVE EASEMENTS,

| 2. National Marine Fisheries Rule 4(d) Review | | |
|---|----|--|
| Yes | No | Will the project involve: |
| | X | a. Construction outside of the footprint of an existing, legal structure? |
| X | | b. Exterior construction within 100-feet of a stream? |
| | X | c. Construction, maintenance or use of a road, bridge, or trail on a stream bank or unstable hill slope? |
| X | | d. Land-use within a riparian area? |
| | X | e. Timber harvesting, mining, grazing or grading? |
| | X | f. Any work inside of a stream, riparian corridor, or shoreline? |
| | X | g. Release or capture of fish or commerce dealing with fish? |
| Please explain any "Yes" answers: | | |
| BIOLOGICAL RESOURCE ASSESSMENT (REFER TO DATED 5/19/2016) | | |
| BY KOPITOV ENVIRONMENTAL LLC. | | |
| | | |
| | | |

| 3. National Pollutant Discharge Elimination System (NPDES) Review | | |
|---|----|---|
| Yes | No | Will the project involve: |
| | X | a. A subdivision or Commercial / Industrial Development that will result in the addition or replacement of 10,000 sq. ft. or more of impervious surface? If yes, Property Owner may be required to implement appropriate source control and site design measures and to design and implement stormwater treatment measures, to reduce the discharge of stormwater pollutants. Please consult the Current Planning Section for necessary forms and both construction and post-construction requirements. |
| | X | b. Land disturbance of 1 acre or more of area? If yes, Property Owner must file a Notice of Intent (NOI) to be covered under the statewide General Construction Activities Storm Water Permit (General Permit) prior to the commencement of construction activity. Proof of coverage under State permit must be demonstrated prior to the issuance of a building permit. |

DECLARATION

I hereby certify that the statements furnished above and in the attached exhibits present the data and information required for this initial evaluation to the best of my ability, and the facts, statements and information presented are true and correct to the best of my knowledge and belief. **If any of the facts represented here change, it is my responsibility to inform the County.**

Signed:  Date: 10/13/2016
(Applicant may sign)

Application for a Coastal Development Permit

455 County Center, 2nd Floor • Redwood City, CA 94063
 Mail Drop: PLN 122 • TEL (650) 363-4161 • FAX (650) 363-4849

Companion Page

Applicant's Name: Carlos Zubieta

Primary Permit #: PLN 2016-0044

1. Instructions

Please fill out the general Planning Permit Application Form and this form when applying for a Coastal Development Permit. You must also submit all items indicated on the checklist found on the reverse side of the Planning Permit Application Form.

2. Basic Information

Does the owner or applicant own any adjacent property not listed?

Yes No

If yes, list Assessor's Parcel Number(s):

37 _ 123 _ 430

 - -

 - -

Have you or anyone else previously applied to either the County of San Mateo or the California Coastal Commission for a Coastal Development Permit for this or a similar project at this location?

Yes No

If yes, explain (include date and application file numbers).

3. Materials and Finish of Proposed Buildings or Structures

Note: By completing this section you do not need to file a separate application for Design Review Approval.

| Fill in Blanks: | Material | Color/Finish | Check if matches existing |
|------------------------|---------------------------------|---------------------------------|---------------------------|
| a. Exterior Walls | Smooth plaster, wood siding | Charleston warm gray, red cedar | <input type="checkbox"/> |
| b. Trim | Zinc Panels | brown and dark bronze | <input type="checkbox"/> |
| c. Roof | Class A 4 ply built-up roofing. | Granite No.4 A1 grit C.O | <input type="checkbox"/> |
| d. Chimneys | n/a | n/a | <input type="checkbox"/> |
| e. Accessory Buildings | n/a | n/a | <input type="checkbox"/> |
| f. Decks/Stairs | Natural wood | Cedar with clear finish | <input type="checkbox"/> |
| g. Retaining Walls | n/a | n/a | <input type="checkbox"/> |
| h. Fences | n/a | n/a | <input type="checkbox"/> |
| i. Storage Tanks | n/a | n/a | <input type="checkbox"/> |

4. Project Information

Does this project, the parcel on which it is located or the immediate vicinity involve or include:

- | | Yes | No |
|---|-------------------------------------|-------------------------------------|
| a. Demolition of existing housing units? (If yes, give value of owner-occupied units or current monthly rent of rental units in explanation below.) | <input type="checkbox"/> | <input checked="" type="checkbox"/> |
| b. Creeks, streams, lakes or ponds? | <input checked="" type="checkbox"/> | <input type="checkbox"/> |
| c. Wetlands (marshes, swamps, mudflats)? | <input type="checkbox"/> | <input checked="" type="checkbox"/> |
| d. Beaches? | <input checked="" type="checkbox"/> | <input type="checkbox"/> |
| e. Sand Dunes? | <input type="checkbox"/> | <input checked="" type="checkbox"/> |
| f. Sea cliff, coastal bluffs or blufftops? | <input checked="" type="checkbox"/> | <input type="checkbox"/> |
| g. Ridgetops? | <input type="checkbox"/> | <input checked="" type="checkbox"/> |
| h. Pampas Grass, invasive brooms or Weedy Thistle? | <input type="checkbox"/> | <input checked="" type="checkbox"/> |
| i. Removal of trees or vegetation? | <input checked="" type="checkbox"/> | <input type="checkbox"/> |
| j. Grading or alteration of landforms? | <input checked="" type="checkbox"/> | <input type="checkbox"/> |
| k. Landscaping? | <input checked="" type="checkbox"/> | <input type="checkbox"/> |
| l. Signs? | <input type="checkbox"/> | <input checked="" type="checkbox"/> |
| m. Phone or utility line extensions or connections, either above or below ground (explain which)? | <input checked="" type="checkbox"/> | <input type="checkbox"/> |
| n. Areas subject to flooding? | <input type="checkbox"/> | <input checked="" type="checkbox"/> |
| o. Development on slopes 30% or steeper? | <input type="checkbox"/> | <input checked="" type="checkbox"/> |

- | | | |
|--|-------------------------------------|-------------------------------------|
| p. Between the sea and the nearest public road? | <input checked="" type="checkbox"/> | <input type="checkbox"/> |
| q. Existing or proposed provisions for public access to the shoreline? | <input type="checkbox"/> | <input checked="" type="checkbox"/> |
| r. Public or commercial recreation facilities? | <input type="checkbox"/> | <input checked="" type="checkbox"/> |
| s. Visitor-serving facilities? | <input type="checkbox"/> | <input checked="" type="checkbox"/> |
| t. Existing or proposed public trail easements? | <input type="checkbox"/> | <input checked="" type="checkbox"/> |

Explain all Yes answers below. Indicate whether the item applies to the project itself, the parcel on which it is located, or the immediate vicinity (attach additional sheets if necessary):

b- Dean Creek sits outside the property, southern P line

d- Beach sits below the adjacent lot in front of subject lot.

f- Bluff abuts adjacent lot in front of subject lot.

i- Removing two (2) Cypress Trees and replacing with four (4) new Cypress Trees

j- Excavation as needed for foundation system and drainage according to Civil Drawings

k- Landscape area under 2500 sqft. All new landscape to be native California plants, per landscape plan

m- Water, power, sewer and phone

p- lot is set back from sea by another lot.

5. Staff Use Only

California Coastal Commission Jurisdiction

A. Does the Proposed Project Involve:

- A subdivision, Certificate of Compliance Type B, Use Permit, or Planned Agricultural District Permit?

| | |
|------------------------------|--|
| <input type="checkbox"/> Yes | <input checked="" type="checkbox"/> No |
|------------------------------|--|
- Construction or grading within 100 feet of a stream or wetland?

| | |
|---|-----------------------------|
| <input checked="" type="checkbox"/> Yes | <input type="checkbox"/> No |
|---|-----------------------------|
- A parcel located between the sea and the first public through road paralleling the sea; 300 feet from the inland extent of any beach or mean high tide line if there is no beach; or within 300 feet of the top of the seaward face of a coastal bluff?

| | |
|---|-----------------------------|
| <input checked="" type="checkbox"/> Yes | <input type="checkbox"/> No |
|---|-----------------------------|

Yes to any one of the above means that the Coastal Development Permit is appealable to the Coastal

Commission; a public hearing is always required.

B. Does the proposed project involve lands below the mean high tide line and lands where the public trust may exist? (See "Post CCP Certification Permit and Appeal Jurisdiction Map).

Yes No

Yes to above means that the California Coastal Commission retains permit jurisdiction over all or part of the proposed project. A Coastal Development Permit from that agency is required.

Reviewed by:

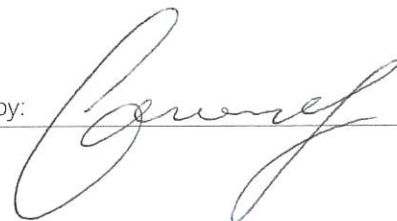

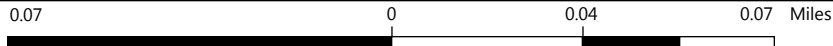
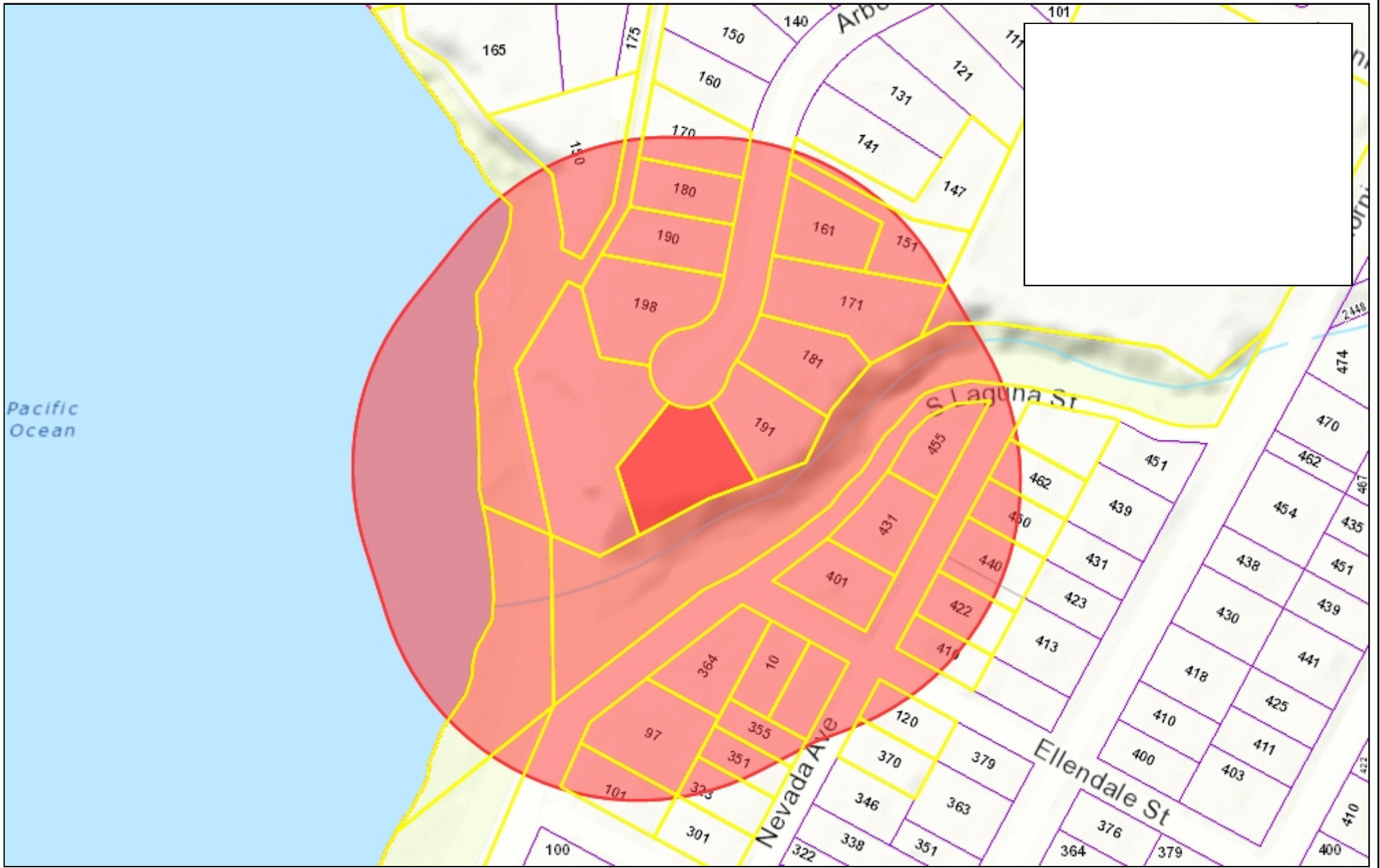

WGS_1984_Web_Mercator_Auxiliary_Sphere
 © Latitude Geographics Group Ltd.

1:2,256 

This map is a user generated static output from an Internet mapping site and is for reference only. Data layers that appear on this map may or may not be accurate, current, or otherwise reliable.

THIS MAP IS NOT TO BE USED FOR NAVIGATION

**COLOR BOARD
MATERIAL SPECIFICATIONS**

RECEIVED

OCT 14 2016

TABLE OF CONTENTS: SPECIFICATIONS San Mateo County
Planning and Building Department

| | |
|--------------|-----------------------------|
| PAGE 1: | COLOR BOARD |
| PAGES 2-8: | CEMENT PLASTER - LA HABRA |
| PAGES 9-19: | WINDOWS AND DOORS - MILGARD |
| PAGES 20-24: | TRIM - VM ZINC |
| PAGES 25-27: | LANDSCAPE LIGHTING |
| PAGES 28-32 | ROOFING |



CARLOS ZUBIETA ARCHITECTS

PROJECT ADDRESS:

199 ARBOR LANE, MOSS BEACH, SAN MATEO COUNTY, CA



1. ROOFING: Class A type 4 ply built up roofing finished with granite No. 5 1/4" by A1 Grit CO.



2. EXTERIOR TRIM: VM ZINC PIGMENTO zinc flat panels in "brown"



3. WINDOWS: Milgard Windows Aluminum Frame - color: dark bronze

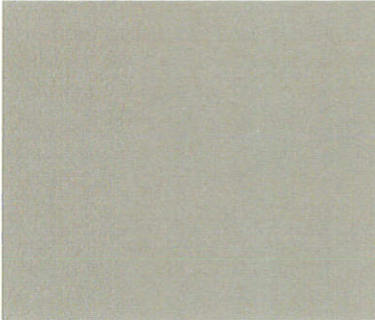

4. EXTERIOR WALLS: Cement plaster La Habra integral color - smooth finish Color - "Charleston"

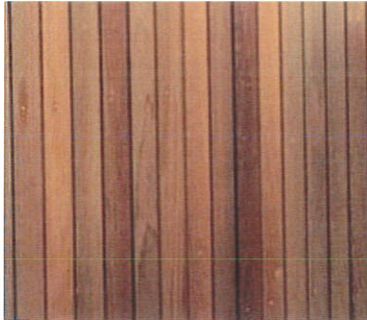

5. EXTERIOR WALLS: Natural wood siding in 4" wide Western Red Cedar siding - clr. polyurethane finish



6. GARAGE DOORS: Natural wood Roll up doors - Western Red Cedar - Clr. polyurethane finish

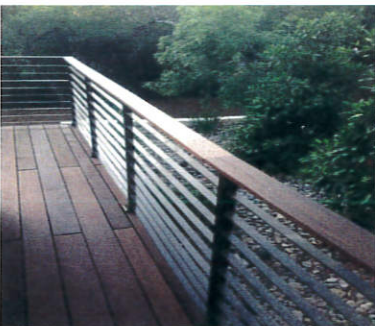

7. RAILINGS / BALCONY: Powder coated steel and natural wood top - bronze color to doors and windows and clr. polyurethane finish



8. OVERHANGS: Natural wood trellis- 4x12 douglas fir beams with clear polyurethane finish

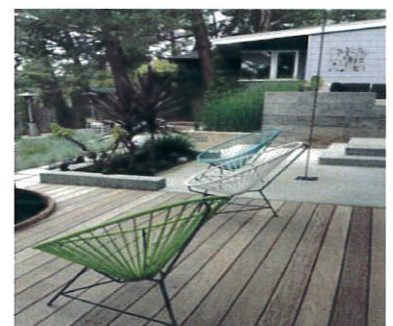

9. HARDSCAPE / DECKS: poured concrete and natural wood decks 2x6 teak clr. polyurethane finish.



PROJECT ADDRESS:

199 ARBOR LANE, MOSS BEACH, SAN MATEO COUNTY, CA

MATERIALS AND FINISHES

- Home
- Products
- Innovations
- Systems & Assemblies
- Support
- Videos
- News & Events
- Projects
- Store

[Distributor Locator](#)

Color Charts

- + Submittals
- + Specifications
- + Details
- + Warranty
- + Tech Support
- + Literature
- + Color Charts
- + Textures
- + **Green/LEED**

Premium Lifestyle Colors

| | | | | |
|---|---|--|---|---|
|  |  |  |  |  |
| Hatteras 63149 (24) Base 100 | Asheville 63152 (29) Base 100 | Coral Gables 81582 (25) Base 100 | Belle Glade 81583 (27) Base 100 | Beaufort 14495 (43) Base 100 |
|  |  |  |  |  |
| Suffolk 81584 (34) Base 100 | Charleston 81585 (35) Base 100 | Bay Ridge 81593 (32) Base 100 | Hialeah 81586 (36) Base 100 | Hanover 63151 (33) Base 100 |
|  |  | | | |
| Morning Side 81588 (30) Base 100 | Biscayne 14496 (39) Base 100 | | | |



CARLOS ZUBIETA ARCHITECTS

PROJECT ADDRESS:

199 ARBOR LANE, MOSS BEACH, SAN MATEO COUNTY, CA

CEMENT PLASTER SPECS.

ACF for Stucco Specifications

CSI SECTION 09 97 23

SECTION 09 97 23 — Concrete and Portland Cement Stucco Coatings *Architectural Coatings and Finishes for Portland Cement Stucco*

PART 1 - GENERAL

1.1 SECTION INCLUDES

- A. Supply and installation of base coat, reinforcing mesh and finish installed over Portland cement stucco.

1.2 RELATED SECTIONS

- A. Section 03 00 00 - Concrete
- B. Section 07 90 00 - Joint Protection
- C. Section 08 50 00 - Windows

1.3 REFERENCES

- A. ASTM C578 Specification for Preformed, Cellular Polystyrene Thermal Insulation
- B. ASTM C847 Standard Specification for Metal Lath
- C. ASTM C897 Standard Specification for Aggregate for Job-Mixed Portland Cement-Based Plaster
- D. ASTM B117 Test Method for Salt Spray (Fog) Testing.
- E. ASTM D2247 Practice for Testing Water Resistance of Coatings in 100 Percent Relative Humidity.
- F. ASTM E84 Test Method for Surface Burning Characteristics of Building Materials.
- G. ASTM E331 Test Method for Water Penetration by Uniform Static Air Pressure Difference.
- H. ASTM E695 Method for Measuring Relative Resistance to Impact Loading.
- I. ASTM E2485 Standard Test Method for Freeze/Thaw Resistance of Exterior Insulation and Finish Systems (EIFS) and Water Resistive Barrier Coatings
- J. ASTM E2486 Standard Test Method for Impact Resistance of Class PB and PI Exterior Insulation and Finish Systems (EIFS)
- K. ASTM G155 Accelerated Weathering for Exposure of Nonmetallic Materials.

1.4 ASSEMBLY DESCRIPTION

- A. An exterior coating system consisting of Base Coat with embedded Reinforcing Fabric Mesh, Primer (Optional), and Finish Coat.

1.5 SUBMITTALS

- A. General: Submit Samples, Evaluation Reports and manufacturer's product data sheets in accordance with Division 1 General Requirements Submittal Section.
- B. Samples: Submit samples for approval. Samples shall be of materials specified and of suitable size as required to accurately represent each color and texture used on project. Prepare each sample using same tools and techniques for actual project application. Maintain and make available, at job site, approved samples.
- C. Manufacturer's Warranty: Submit sample copies of Manufacturer's Warranty indicating Single Source Responsibility for stucco assembly materials.

1.6 QUALITY ASSURANCE

A. Qualifications:

- 1. Manufacturer: Shall have marketed stucco assemblies in United States for at least ten years and

2. Applicator: Shall be experienced and competent in installation of stucco materials, and shall provide evidence of a minimum of five years experience in work similar to that required by this section.
 3. Products manufactured under ISO 9001:2000 Quality System.
- B. Architectural Coatings and Finishes for Portland cement stucco Functional Criteria:
1. General:
 - a. Inclined surfaces shall follow the guidelines listed below:
 - (1) Minimum slope: 6 in (152 mm) of vertical rise in 12 in (305 mm) of horizontal run.
 - (2) For sloped surfaces, run of slope shall be a maximum of 12 in (305 mm).
 - (3) Usage not meeting above criteria shall be approved by Parex USA prior to installation.
 - b. Flashing: Flashing shall be continuous and watertight. Flashing shall be designed and installed to prevent water infiltration behind the LaHabra Architectural Coatings and Finishes for Portland cement stucco. Refer to Division 7 Flashing section for specified flashing materials.
 - c. Expansion joints: Continuous expansion joints shall be installed per contract documents
 - d. Building code conformance: The construction shall be acceptable for use under the building code in force in the jurisdiction of the project.
 2. Performance Requirements: Shall meet the testing requirements of the Product Performance Sheet.

1.7 DELIVERY, STORAGE, AND HANDLING

- A. Delivery: Deliver assembly materials in original packaging with manufacturer's identification.
- B. Storage: Store assembly materials in a dry location, out of direct sunlight, off the ground, and protected from moisture.

1.8 PROJECT / SITE CONDITIONS

- A. Substrate Temperature: Do not apply stucco assembly materials to substrates whose temperature are below 40°F (4°C) or contain frost or ice.
- B. Inclement Weather: Do not apply stucco assembly materials during inclement weather, unless appropriate protection is employed.
- C. Sunlight Exposure: Avoid, when possible, installation of the stucco assembly materials in direct sunlight. Application of finishes in direct sunlight in hot weather may adversely affect aesthetics.
- D. Do not apply stucco base coats or finishes if ambient temperature falls below 40°F (4°C) within 24 hours of application. Protect stucco materials from uneven and excessive evaporation during dry weather and strong blasts of dry air.
- E. Prior to installation, the substrate shall be inspected for surface contamination, or other conditions that may adversely affect the performance of the stucco assembly materials, and shall be free of residual moisture.

1.9 COORDINATION AND SCHEDULING:

- A. Coordination: Coordinate Architectural Coatings and Finishes installation with other construction operations.

1.10 WARRANTY

- A. Warranty: Upon request, at completion of installation, provide manufacturer's Standard Limited Warranty.

PART 2 - PRODUCTS

2.1 MANUFACTURERS

- A. Manufacturer, Basis of Design: Parex USA, Inc., 4125 E. La Palma Ave., Suite 250, Anaheim, CA 92807 Contact: Architectural Sales (866.516.0061) or Technical Support (800.226.2424).
- B. Components: Obtain components manufactured by Parex USA of LaHabra Fastwall 300 Stucco Assembly from authorized distributors. No substitutions or additions of other materials are permitted without prior written permission from Parex USA for this project

2.2 MATERIALS

A. Basecoats:

- [1. Parex USA WeatherDry: Waterproofing Base Coat. Acrylic co-polymer base. Requires the addition of portland cement.
- [2. Insul-Bond Wet Base Coat: 100% acrylic polymer base, requiring the addition of portland cement
- [3. Insul-Bond Dry Base Coat: Copolymer based, factory blend of cement and proprietary ingredients requiring addition of water.
- [4. Parex USA Stucco Level Coat: Copolymer based, factory blend of cement and proprietary ingredients requiring addition of water.

EDITOR NOTE: REINFORCING MESH IS USED FOR GAUGING THE THICKNESS OF THE BASE COAT AND IS REQUIRED WITH PAREX USA WEATHERDRY

B. Reinforcing Mesh

- [1. Parex USA 355 Standard Mesh: Weight 4.5 oz. per sq. yd. (153 g/sq m); coated for protection against alkali. Standard reinforcement of EIFS, or for use with High Impact 358.14 Mesh, or Ultra High Impact 358.20 Mesh.

C. Primers

- [1. Parex USA Primer: 100% acrylic based coating to prepare surfaces for finishes.
- [2. Variance VariPrime Sanded: 100% acrylic based coating to prepare surface for Cerastone and Spraystone finishes.

EDITOR NOTE: MODIFY BELOW TO SUIT REQUIREMENTS. CHOOSE ONE FINISH TYPE, TEXTURE, & COLOR WITH ACCESSORY MATERIALS TO CREATE DESIRED EFFECT

D. Finish:

- [1. Perma- Finish: Factory blended, 100% acrylic polymer based finish, integrally colored. Finish type, texture and color as selected by Architect.
- [2. Perma-ELastic® Finish: Factory blended, 100% acrylic polymer based elastomeric textured finish, integrally colored. Finish type, texture and color as selected by Project Designer
- [3. Variance Finish [enter selected product]: Acrylic-based specialty finish. Finish type, texture and color as selected by Project Designer.
 - a. Variance Antiquing Gel: a water-based, tinted, semi-transparent, acrylic emulsion for staining, sealing, and protecting concrete, portland cement stucco and other cementitious substrates. Use as required to achieve desired finish.
 - b. Variance VariSeal is a 100% acrylic, water based sealer. Improves scratch and scuff resistance and adds depth of color.

EDITOR NOTE: ADD CLEAR SEALER WHERE ENHANCED CLEANABILITY IS DESIRED FOR HIGH SOILING EXPOSURES.

- [4. Parex USA Clear Sealer: 100% acrylic, transparent, permeable, dirt resistant sealer for use as a protective coating over acrylic finishes. Use 600 Clear or 610 Matte Clear as detailed on drawings.

E. Water: Clean, potable water

F. Portland Cement: ASTM C150, Type I or Type I-II.

2.3 RELATED MATERIALS AND ACCESSORIES

A. Substrate Materials:

- [1. Concrete Portland cement stucco Units (CMU): Non-painted (uncoated).
- [2. Concrete (poured or pre-cast).
- [3. Unglazed brick and portland cement stucco units.
- [4. Other Approved by Parex USA in writing prior to the project

B. Flashing: Refer to Division 7 Flashing Section for flashing materials.

C. Sealant System:

1. Sealants shall conform to ASTM C920, Grade NS.
2. Expansion joints between sections of EIFS shall have a minimum width of 3/4 in (19 mm).
3. Sealant backer rod shall be closed-cell polyethylene foam.
4. Apply sealant to tracks or base coat.
5. Refer to Parex USA current bulletin for listing of sealants which have been tested and have been found to be compatible with EIFS.
6. Color shall be as selected by Architect.
7. Joint design, surface preparation, and sealant primer shall be based on sealant manufacturer's recommendations and project conditions.

EDITOR NOTE: PART 3 EXECUTION BELOW INVOLVES ONSITE WORK AND SHOULD INCLUDE PROVISIONS FOR INCORPORATING MATERIALS AND PRODUCTS INTO PROJECT. TYPICALLY, "CONDITIONS OF THE CONTRACT" ESTABLISH RESPONSIBILITY FOR "MEANS, METHODS, TECHNIQUES, AND SAFETY" REQUIREMENTS OF CONSTRUCTION WITH CONTRACTOR. SPECIFICATIONS SHOULD AVOID CONFLICTS WITH THIS CONTRACTUAL PRINCIPLE.

PART 3 - EXECUTION

3.1 EXAMINATION

- A. Verify project site conditions under provisions of Section 01 00 00.
- B. Compliance: Comply with manufacturer's instructions for installation of coatings.
- C. Substrate Examination: Examine prior to Base Coat installation as follows:
 1. Substrate shall be free of dust, dirt, laitance, efflorescence, and other harmful contaminants.
 2. Substrate construction in accordance with substrate material manufacturer's specifications and applicable building codes.
 3. Substrate shall be cured concrete (28 days minimum)
 4. Substrate shall have no irregularities greater than 1/4" (6.4 mm), and shall be sound and free of foreign substances, including paint, bond breakers, form oils, laitance, scaling and flaking.
 5. Unsatisfactory conditions shall be corrected before the application of the coatings.
 6. Painted surfaces shall have paint removed to achieve a substrate with 90% or more of the surface free of paint.
 7. Sanding surfaces shall be eliminated mechanically, then washed with clear water.
 8. Remove efflorescence using mechanical removal and/or a diluted acid solution followed by complete rinsing.
 9. Concrete surfaces shall be level and free of voids over 1/8" (3 mm) across. Glossy surfaces shall be dulled by chemical or mechanical means. Thoroughly remove all residues.
- D. Advise Contractor of discrepancies preventing installation of the LaHabra Architectural Coatings and Finishes. Do not proceed with the LaHabra Architectural Coatings and Finishes work until unsatisfactory conditions are corrected.

3.2 PREPARATION

- A. Protection: Protect surrounding material surfaces and areas during installation of system.
- B. Clean surfaces thoroughly prior to installation.
- C. Prepare surfaces using the methods recommended by the Manufacturer for achieving the best result for the substrate under the project conditions.

3.3 MIXING

- A. Mix proprietary products in accordance with Manufacturer's instructions.

3.4 APPLICATION

- A. General: Installation shall conform to this specification and Parex USA written instructions and drawing details.
- B. Base coat
 - 1. If leveling is required, apply any LaHabra Base Coat. LaHabra Base Coat may be applied up to 3/8" (9.5 mm) and 121 Dry up to 1/2 in. (13 mm) thick in a single pass when used as a leveler.
 - 2. Apply base coat and fully embed mesh if applicable in base coat.
- C. Bond supplemental EPS shapes as indicated on the drawings. Bond shapes to EPS or to dry reinforced base coat using any LaHabra Base Coat & Adhesive as an adhesive. Allow 24 hours to dry. Refer to Standard System Specification for materials and installation of Base Coat and Mesh over EPS shapes.
- D. Apply primer to base coat after drying. Primer may be omitted if it is not required by the Manufacturer's product data sheets for the specified finish coat or otherwise specified for the project.
- E. Finish Coat: Apply finish coat to match specified finish type, texture, and color. Do not apply finish coat to surfaces to receive sealant. Keep finish out of sealant joint gaps.

3.5 CLEAN-UP

- A. Removal: Remove and legally dispose of LaHabra Architectural Coatings and Finishes for Portland cement stucco component debris material from job site.
- B. Clean EIFS surfaces and work area of foreign materials resulting from EIFS operations.

3.6 PROTECTION

- A. Provide protection of installed materials from water infiltration into or behind them.
- B. Provide protection of installed stucco from dust, dirt, precipitation, and freezing during installation.
- C. Provide protection of installed finish from dust, dirt, precipitation, freezing and continuous high humidity until fully cured and dry.
- D. Clean exposed surfaces using materials and methods recommended by the manufacturer of the material or product being cleaned. Remove and replace work that cannot be cleaned to the satisfaction of the Architect/Owner.

END OF SECTION

Rev. June 2013

Disclaimer: This guide specification is intended for use by a qualified designer. The guide specification is not intended to be used verbatim as an actual specification without appropriate modifications for the specific use intended. The guide specification must be integrated into and coordinated with the procedures of each design firm, and the requirements of a specific project. For additional assistance, contact Parex USA's Architectural Sales (866.516.0061) or Technical Support (800-226-2424).

Product Performance Sheet | Page 1

Architectural Coatings and Finishes

| Fire Performance | Method | ICC or ASTM Criteria | Results |
|--------------------------------|----------|---|---|
| Surface Burning Characteristic | ASTM E84 | Individual components shall each have a flame spread <25, and smoke developed < 450 | Flame Spread: 0 to 15 Smoke Developed: 0 to 15 |

| EIFS Strength | Method | ICC or ASTM Criteria | Results |
|------------------------------|------------|-------------------------|--|
| Flexural Strength | ASTM C203 | No Requirement | 60.6 psi (418 kPa) |
| Falling Ball Impact | ASTM D1037 | No Requirement | 92 to over 600 in-lbs |
| Creep Resistance of Adhesive | ASTM D2294 | No Requirement | 28 days 208 psf shear stress: no creep |
| Tensile Bond Strength | ASTM E2134 | Minimum 15 psi (103kPa) | Pass |

| Environmental Durability | Method | ICC or ASTM Criteria | Results |
|--------------------------|---------------------------------------|--|--------------------------|
| Abrasion Resistance | ASTM D968 | No cracking or loss of film at 528 quarts (500 L) of sand | Pass: 500 Liters |
| Accelerated Weathering | ASTM G153/ (ASTM G23) ASTM G154 | No deleterious effects* at 2000 hours when viewed under 5x magnification | Pass: 2000 Hours |
| Freeze/Thaw Resistance | ASTM E 2485 | No deleterious effects* at 10 cycles when viewed under 5x magnification | Pass: 60 cycles |
| Fungus Resistance | MIL STD 810B | No Requirement | Pass: 28 days- no growth |
| Mildew Resistance | ASTM D3273 | No growth supported during 28 day exposure period | Pass |
| Water Penetration | ASTM E331 | No water penetration beyond the plane of the base coat/EPS board interface after 15 minutes at 6.24 psf (299 Pa) | Pass |
| Moisture Resistance | ASTM D2247 | No deleterious effects at 14 day exposure | Pass |
| Salt Fog Resistance | ASTM B117 | No deleterious effects* at 300 hours | Pass: 500 hours |
| Wind Driven Rain | F.S. TT-C-555B | No Requirement | Pass: 24 hours |

**No deleterious effects: no cracking, checking, crazing, erosion, rusting, blistering.*

Where several tests on different materials are summarized, a range of values is shown. This summary has been prepared to provide quick but partial information on how certain combinations of Parex USA products perform during certain tests. It is not a complete description of the test procedures or of the results thereof. Copies of original test reports are available at no charge upon request. Please contact Parex USA's Architectural Sales (866-516-0061) or Technical Support Department (800-226-2424) if further information is required.



3 Part Specification Thermally Improved Aluminum Windows

GENERAL NOTES TO SPECIFIER:

THIS SPECIFICATION SYSTEM HAS BEEN PREPARED TO ASSIST DESIGN PROFESSIONALS IN THE PREPARATION OF PROJECT OR OFFICE MASTER SPECIFICATIONS. IT FOLLOWS GUIDELINES ESTABLISHED BY THE CONSTRUCTION SPECIFICATIONS INSTITUTE, AND THEREFORE MAY BE USED WITH MOST MASTER SPECIFICATION SYSTEMS WITH MINOR EDITING.

EDIT CAREFULLY TO SUIT PROJECT REQUIREMENTS. MODIFY AS NECESSARY AND DELETE ITEMS THAT ARE NOT APPLICABLE. VERIFY THAT REFERENCED SECTION NUMBERS AND TITLES ARE CORRECT (NUMBERS AND TITLES REFERENCED ARE BASED ON MASTERFORMAT, 2004 EDITION.)

THIS SECTION ASSUMES THE PROJECT MANUAL WILL CONTAIN COMPLETE DIVISION 1 DOCUMENTS INCLUDING 01 25 13 – PRODUCT SUBSTITUTION PROCEDURES, SECTIONS 01 33 00 – SUBMITTAL PROCEDURES, 01 62 00 – PRODUCT OPTIONS, 01 66 00 – PRODUCT STORAGE AND HANDLING REQUIREMENTS, 01 74 00 – CLEANING AND WASTE MANAGEMENT, 01 77 00 – CLOSEOUT PROCEDURES, AND 01 78 00 –CLOSEOUT SUBMITTALS. CLOSE COORDINATION WITH DIVISION 1 SECTIONS IS REQUIRED. IF THE PROJECT MANUAL DOES NOT CONTAIN THESE SECTIONS, ADDITIONAL INFORMATION SHOULD BE INCLUDED UNDER THE APPROPRIATE ARTICLES.

THIS IS AN OPEN PROPRIETARY SPECIFICATION ALLOWING USERS THE OPTION OF APPROVING OTHER MANUFACTURERS THAT COMPLY WITH THE CRITERIA SPECIFIED HEREIN.

NOTES TO THE SPECIFIER ARE CONTAINED IN BOXES AND SHOULD BE DELETED FROM FINAL COPY.

OPTIONAL ITEMS REQUIRING SELECTION BY THE SPECIFIER ARE ENCLOSED WITHIN BRACKETS, E.G. [35] [40] [45]. MAKE APPROPRIATE SELECTIONS AND DELETE OTHERS.

ITEMS REQUIRING ADDITIONAL INFORMATION ARE UNDERLINED BLANK SPACES, E.G. _____.

OPTIONAL PARAGRAPHS REQUIRING SELECTION OF ONE OF THE OPTIONS ARE SEPARATED BY "OR" WITHIN A BOX. E.G.

OR

BOLD FACE TYPE IDENTIFIES OPTIONAL PARAGRAPHS AND FEATURES THAT MAY BE INCLUDED OR DELETED DEPENDING UPON PROJECT REQUIREMENTS. CONVERT THE BOLD FACE TYPE TO REGULAR TYPE WHEN INCLUDING THESE PARAGRAPHS OR FEATURES.

REVISE FOOTER TO SUIT PROJECT/OFFICE REQUIREMENTS.

ELECTRONIC VERSIONS OF THIS SPECIFICATION UTILIZE AUTOMATIC PARAGRAPH NUMBERING.

WHEN EDITING IS COMPLETE, DELETE ALL TEXT ON THIS PAGE, THEN REMOVE THE SECTION BREAK AT THE TOP OF THE NEXT PAGE TO REMOVE THIS PAGE FROM THE DOCUMENT.



PROJECT ADDRESS:

199 ARBOR LANE, MOSS BEACH, SAN MATEO COUNTY, CA



3 Part Specification Thermally Improved Aluminum Windows

THERMALLY IMPROVED (TIE) ALUMINUM WINDOWS - 08 51 13

With the thin lines that Milgard's TIE Aluminum Windows provide, they are ideal for both new construction as well as replacement. This series of products provide an economical solution while providing architectural style.

TIE Aluminum Windows

PART 1 – GENERAL

1.01 SUMMARY

A. Section Includes:

1. Solid and tubular aluminum extruded windows of the following type(s):

| | |
|-------------------|-----------------|
| Picture Window | Series 920, 921 |
| Casement | Series 920, 921 |
| Awning | Series 920, 921 |
| Horizontal Slider | Series 1120 |
| Vertical Slider | Series 1520 |
| Bay Window | Series 1551 |
| Bow Window | Series 1561 |
| Radius | Series R20 |

B. Related Sections:

INSERT APPROPRIATE SECTION NUMBERS AND TITLES BELOW FOR WINDOW FLASHING AND INSTALLATION SEALANTS.

1. _____ - _____.
2. _____ - _____.
3. 08 32 13 – **TIE Aluminum Sliding Doors.**

INCLUDE APPROPRIATE LANGUAGE BELOW IF PRODUCTS SPECIFIED IN THIS SECTION ARE TO BE BID AS ALTERNATES. OTHERWISE DELETE FOLLOWING PARAGRAPH.

C. Alternates:

1. Reference Section 01 23 00 – Alternates.

TIE Aluminum Windows (continued)

1.02 SUBMITTALS

- A. Reference Section 01 33 00 – Submittal Procedures; submit following items:
 - 1. Product Data.
 - 2. Shop Drawings: Include window schedule, window elevations, sections and details, and multiple window assembly details.
 - 3. Samples:
 - a. Color samples: Minimum 1x4 inch (25x100 mm) samples of Aluminum with painted or anodized color.
 - b. Glass, showing specified tint color.**
 - 4. Quality Assurance/Control Submittals:
 - a. Qualifications: Proof of manufacturer's qualifications.
 - b. U-Factor and structural rating charts required for AAMA and NFRC labeling requirements.**
 - c. Installation Instructions – AAMA 2400 ("Mounting Flange Installation")
- B. Closeout Submittals: Reference Section 01 78 00 – Closeout Submittals; submit following items:
 - 1. Temporary window labels marked to identify windows that labels were applied to.
 - 2. Maintenance instructions.
 - 3. Special Warranties.

1.03 QUALITY ASSURANCE

- A. Overall Standards: Comply with ANSI/AAMA 101.I.S.2, except as otherwise noted herein.
- B. Qualifications:
 - 1. Manufacturer Qualifications:
 - a. Minimum five years experience in producing aluminum windows of the type(s) specified.
 - b. Member AAMA, NFRC.

INSERT LOCAL REGULATORY REQUIREMENTS BELOW.

TIE Aluminum Windows (continued)

C. Regulatory Requirements:

D. Certifications for insulated glass windows:

1. AAMA: Windows shall be Gold Label certified with label attached to frame per AAMA requirements.
2. NFRC: Windows shall be NFRC certified with temporary U-factor label applied to glass and an NFRC tab added to permanent AAMA frame label.

1.04 DELIVERY, STORAGE AND HANDLING

- A. Reference section 01 66 00 - Product Storage and Handling Requirements.
- B. Follow manufacturer's instructions on label applied to windows.

1.05 WARRANTY

SELECT "RESIDENTIAL" WARRANTY BELOW FOR OWNER OCCUPIED SINGLE FAMILY RESIDENTIAL AND OWNER OCCUPIED CONDOMINIUM PROJECTS. SELECT "COMMERCIAL WARRANTY FOR NON-OWNER OCCUPIED CONDOMINIUMS, COMMERCIAL, AND MULTI-FAMILY PROJECTS.

A. Residential Special Warranty:

1. Lifetime guarantee to original owner.
2. Transferability:
 - a) Permit unlimited transfer of ownership in first ten years.
 - b) Upon first transfer of ownership, guarantee period shall become ten years from date of original purchase.
3. Guarantee windows against defect in materials and workmanship including costs for parts and labor.

OR

B. Commercial Special Warranty:

1. 10-year guarantee.
2. Guarantee windows against defects in manufacturing and workmanship including costs for parts and labor.

TIE Aluminum Windows (continued)

PART 2 – PRODUCTS

2.01 MANUFACTURER

- | | |
|---|---|
| A. Milgard Manufacturing, Inc. 1010 54 th Avenue East Tacoma, WA 98424 | Tel: 1.800.MILGARD (645-4273) (253) 922-2030 Fax: (253) 926-0848 Web: milgard.com |
|---|---|

INSERT NAME, ADDRESS AND PHONE NUMBERS OF MANUFACTURER'S REPRESENTATIVE BELOW

1. Manufacturer's Representative:

| | |
|--|--------------|
| | Tel: _____ |
| | Fax: _____ |
| | Email: _____ |

- B. Window Series: Milgard TIE Aluminum Windows
- C. Substitutions: Reference Section 01 25 13 – Product Substitutions Procedures.

2.02 MATERIALS

- A. Aluminum: Comply with requirements of AAMA/WDMA/CSA 101/I.S.2/A440-05, 6063-T5 temper for strength, corrosion resistance and application of required finish.
- B. Extruded frame members are to be .060" in thickness for structural walls.

VERIFY THAT WINDOW FLASHING MATERIAL AND INSTALLATION SEALANT IS SPECIFIED IN APPROPRIATE SECTIONS.

2.03 GENERAL PERFORMANCE REQUIREMENTS:

- A. Thermal Performance: Comply with NFRC 100.
- B. Air Leakage, Water Resistance, Structural Test: Comply with ANSI/AAMA 101/I.S.2.
- C. Forced-Entry Resistance: Comply with ASTM E 588.

TIE Aluminum Windows (continued)

2.04 WINDOW TYPES:

SELECT FOLLOWING WINDOW TYPES AND RELATED NAIL FIN/MOUNTING STYLE BASED ON PROJECT REQUIREMENTS.
DELETE WINDOW TYPES NOT USED.

A. Picture Window and Radius – [920 Series, 1 3/8 inch (35mm) nail fin setback] [921 Series, block frame (no nail fin)] [R20 Series, 1 3/8 inch (35mm) nail fin setback]:

1. Frame:
 - a. 920 Series, 2 ¼" (57mm)
 - b. 921 Series, 1 ½" (38mm)
 - c. R20 Series, 2 ¼" (57mm)
2. Sightlines:
 - a. 920 Series, equal to 1 5/16"
 - b. 921 Series, equal to 1 13/16"
 - c. R20 Series, equal to 1 5/16"
3. Performance Class:
 - a. 920 & 921 Series, 95 ½" x 71 ½" and smaller: F-HC45
 - b. R20 Series, 71 ½" x 71 ½" and smaller: F-HC40

B. Horizontal Slider – [1120 Series, 1 3/8 inch (35mm) nail fin setback]:

1. Frame:
 - a. 1120 Series, 2 5/8" (67mm)
2. Sash: Depth of 1 1/8" (29 mm), solid aluminum extrusion.
3. Sightlines: Non-equal sightlines between sash and fixed glass.
4. Performance Class:
 - a. 143 ½" x 59 ½" and smaller: HS-R20.
5. Hardware:
 - a. Nylon rollers with stainless steel axles, aluminum integral monorail track.
 - b. Single pull rail on meeting rail sash.
 - c. Automatic, spring loaded, height adjustable positive lock.
6. Weatherstripping: Fin seal polypropylene pile.

- C. Single Hung – [1520 Series, 1 3/8 inch (35mm) nail fin setback]
1. Frame:
 - a. 1520 Series, 2 5/8" (67mm)
 2. Sash: Depth of 1 1/8" (29 mm), solid aluminum profile.
 3. Sightlines: Non-equal sightlines between sash and fixed glass.
 4. Performance Class:
 - a. 53 1/2" x 89 1/2" and smaller: H-LC25.
 5. Hardware:
 - a. Concealed block and tackle balancer.
 - b. Single pull rail (sash lifts) on meeting rail sash.
 - c. Automatic, spring loaded, width adjustable positive lock.
 6. Weatherstripping: Fin seal polypropylene pile.
- D. Casement – [920 Series, 1 3/8 inch (35mm) nail fin setback] [921 Series, block frame (no nail fin)]:
1. Frame:
 - a. 920 Series, 2 1/4" (57mm)
 - b. 921 Series, 1 1/2" (38mm)
 2. Sash: Depth of 1 1/2" (38mm), solid aluminum extrusion.
 3. Performance Class:
 - a. 95 1/2" x 59 1/2" Double Casement with center fixed, 36 vent set: C-C30.
 4. Hardware:
 - a. Cam style locking mechanism with latch on jamb.
 - b. Tension adjustable hinge.
 5. Weatherstripping: Dual durometer vinyl bulb seal.
- E. Awning – [920 Series, 1 3/8 inch (35mm) nail fin setback] [921 Series, block frame (no nail fin)]:
1. Frame:
 - a. 920 Series, 2 1/4" (57mm)
 - b. 921 Series, 1 1/2" (38mm)
 2. Sash: Depth of 1 1/2" (38mm), solid aluminum extrusion.

3. Performance Class:
 - a. 48 1/2" x 83 1/2" Bottom Awning, 36" barset: AP-C30.
 4. Hardware:
 - a. Cam style locking mechanism with latch on jamb.
 - b. Tension adjustable hinge.
 5. Weatherstripping: Dual durometer vinyl bulb seal.
- F. Bay Windows – [1551 Series, 1 3/8 inch (35 mm) nail fin setback]:
1. Frame: Depth of frame is 2 5/8" (67mm)
 2. Unit configuration and window types as shown on drawings; mullled together to form single window unit.
 3. Assembly posts at 45 degrees.
- G. Bow Windows – [1561 Series, 1-3/8 inch (35 mm) nail fin setback]:
1. Frame: Depth of frame is 2 5/8" (67mm)
 2. Unit configuration and window types as shown on drawings; mullled together to form single window unit.
 3. Assembly posts at 13 degrees.

TIE Aluminum Windows (continued)

2.05 GLAZING

A. Insulated Glass Units: ASTM E 774, Class A, 1 inch (25 mm) thick overall except 1120/1520 series, which are 3/4 inch (19mm) thick.

1. Glazing Type: [Clear/Clear] [Clear/SunCoat® Low-E] [Clear/SunCoat® Low-E, argon gas filled] [Clear/SunCoatMAX™ Low-E] [Clear/SunCoatMAX™ Low-E, argon gas filled] [Clear/Hardcoat Low-E] [Clear/Hardcoat Low-E, argon gas filled].

WARM EDGE SPACERS ARE NOT AVAILABLE ON SOME UNITS INCLUDING CERTAIN OVERSIZE UNITS, RADIUS AND GABLED UNITS.

2. Spacer Bar: [Warm edge steel spacer] [Aluminum box spacer] [Warm edge foam spacer].

MOST COMMON TYPES OF INSULATED UNITS ARE INCLUDED ABOVE, BUT SEVERAL OTHER TYPES INCLUDING TINTED, REFLECTIVE, HEAT STRENGTHENED, TEMPERED, OBSCURE, WIRE, AND LAMINATED ARE AVAILABLE FOR SPECIAL APPLICATIONS. SELECT DESIRED TYPES FROM MILGARD WEBSITE milgard.com/architects AND SPECIFY IN LIEU OF, OR IN ADDITION, TO THE ABOVE WITH ALL NECESSARY CRITERIA SUCH AS OBSCURE PATTERNS. IF MORE THAN ONE TYPE OF GLAZING IS REQUIRED FOR THE PROJECT, BE CERTAIN THAT TYPE FOR EACH WINDOW IS CLEARLY NOTED ON DRAWINGS OR IN WINDOW SCHEDULE.

OR

B. Single Pane Glass:

1. Glazing Type: [Clear] [Solar Bronze] [Solar Gray] [Hardcoat Low-E] [Solar Cool Bronze] [Solar Cool Gray].

MOST COMMON TYPES OF SINGLE PANE GLASS ARE INCLUDED ABOVE, BUT SEVERAL OTHER TYPES INCLUDING REFLECTIVE, HEAT STRENGTHENED, TEMPERED, OBSCURE, WIRE, AND LAMINATED ARE AVAILABLE FOR SPECIAL APPLICATIONS. SELECT DESIRED TYPES FROM MILGARD WEBSITE milgard.com/architects AND SPECIFY IN LIEU OF, OR IN ADDITION, TO THE ABOVE WITH ALL NECESSARY CRITERIA SUCH AS OBSCURE PATTERNS. IF MORE THAN ONE TYPE OF GLAZING IS REQUIRED FOR THE PROJECT, BE CERTAIN THAT TYPE FOR EACH WINDOW IS CLEARLY NOTED ON DRAWINGS OR IN WINDOW SCHEDULE.

2.06 DIVIDED LITE GRIDS

VERIFY THAT DESIRED GRID PATTERNS, IF ANY, ARE SHOWN ON THE DRAWING. CERTAIN GRID PATTERNS MAY NOT BE AVAILABLE WITH ONE OR THE OTHER BAR TYPES IN THE FOLLOWING PARAGRAPH - CONSULT MILGARD FOR UNUSUAL DESIGN APPLICATIONS. GRIDS ARE NOT AVAILABLE FOR SINGLE PANE GLASS WINDOWS.

- A. [5/8 inch (16 mm) wide flat, grids between the glass that are color matched to frame and sash] [1-1/16 inch (27 mm) wide sculptured, grids between the glass that are color matched to frame and sash]

TIE Aluminum Windows (continued)

2.07 INSECT SCREENS

- A. Provide tight-fitting screen for operating sash with hardware to allow easy removal.
 - 1. Screen Cloth: Charcoal colored fiberglass mesh.
 - 2. Frame:
 - a. Cambered formed aluminum with rigid plastic corner keys.
 - b. Pull tabs for removal.

2.08 FABRICATION

- A. Fabricate frames and sash with mechanically joined corners. Corners are fastened with corrosion resistant screws and sealed with an acrylic sealant.
- C. All fixed glass is exterior glazed and all sashes are marine glazed with flexible PVC glazing. The fixed glazing shall be removed without disassembly of a sash. The vents will need to be disassembled to replace the glazing.

2.09 FINISHES

- A. Frame and Sash Color: [Bronze] [Clear] Anodized Exterior Finish: Provide AA-C22-A32 Class II Bronze or AA-C22-A31 Class II Clear finish, minimum 0.4 mils thick, electrolytically deposited color anodized finish.
- B. Color match screen frame to window frame and sash color.

2.10 SOURCE QUALITY CONTROL

- A. Windows inspected in accordance with manufacturer's Quality Control Program as required by AAMA Gold Label certification.

PART 3 - EXECUTION

3.01 EXAMINATION

- A. Examine openings in which windows will be installed.
 - 1. Verify that framing complies with AAMA 2400 ("Mounting Flange Installation") or AAMA 2410 ("Flush Fin Installation").
 - 2. Verify that fasteners in framed walls are fully driven and will not interfere with window installation.
- B. Coordinate with responsible entity to correct unsatisfactory conditions.

TIE Aluminum Windows (continued)

- C. Commencement of work by installer is acceptance of substrate conditions.

3.02 INSTALLATION

INSTALLATION INSTRUCTIONS (AAMA 2400) ARE ADEQUATE FOR NORMAL INSTALLATION CONDITIONS IN FRAMED CONSTRUCTION. MASONRY WALLS AND UNUSUAL CONDITIONS MAY REQUIRE ADDITIONAL INFORMATION IN THIS ARTICLE.

- A. Install windows in framed walls in accordance with AAMA 2400 ("Mounting Flange Installation") or AAMA 2410 ("Flush Fin Installation").
- B. Do not remove temporary labels.
- C. Install insect screens on operable sash.**

3.03 CLEANING

- A. Reference Section 01 74 00 – Cleaning and Waste Management.
- B. Remove temporary labels and retain for Closeout Submittals.
- C. Clean soiled surfaces and glass using a mild detergent and warm water solution with soft, clean cloths.

END OF SECTION

This specification was prepared by Milgard Manufacturing, Inc. Comments or suggestions for improvement should be addressed to Milgard at the address in Article 2.01 A.

Issue Date: October 31, 2007

VMZINC is a non-ferrous, self-protecting metal. Natural zinc forms its own protective layer, called a patina, when it is in contact over time with air (oxygen and carbon dioxide) and water. VMZINC offers seven zinc surface colours in addition to the Natural zinc which is sometimes referred to as mill finish zinc.

Natural VMZINC® Natural VMZINC has a shiny metallic appearance when new and develops a patina over time. In facade applications, it may take 10 years for the matt grey patina to form.

QUARTZ-ZINC® QUARTZ-ZINC offers an appearance and texture that does not change over time. When QUARTZ-ZINC is scratched, it will self heal. The grey tones of QUARTZ-ZINC blend well with existing construction materials. QUARTZ-ZINC is produced through a phosphatation of mill finish Natural zinc. The darkness of the pre-weathered zinc is measured electronically using a Y figure where 0 is black and 100 is white. Acceptable tolerance of QUARTZ-ZINC, Y = 22 to 25.

ANTHRA-ZINC® ANTHRA-ZINC with its visible grain matches the colour of slate. ANTHRA-ZINC is produced through a phosphatation of mill finish Natural zinc. Acceptable tolerance of ANTHRA-ZINC, Y = 5 to 7. ANTHRA-ZINC also includes a thin organic coating with a tolerance of shininess of 6 to 10. Due to the dark colour of ANTHRA-ZINC it should be carefully considered before using on non-rinsed surfaces such as protected facades and soffits.

AZENGAR®
New AZENGAR is the new surface finish from VMZINC which is the first engraved zinc giving a product with a matt, heterogeneous and light aspect. AZENGAR can be used in the same fashion as other VMZINC products for both roofs and facades, however it will not be available in PLUS in 2014.

PIGMENTO® Finishes offer a unique range of colours that enhances any building. This natural product enables the texture of the QUARTZ-ZINC to still be seen whilst offering the designer the choice of colour to complement other elements of a building's facade or roof. The colouration of the zinc is achieved with a special pigment layer that enhances the qualities of the zinc without presenting a block colour. This product is tested to EN13523-10:2010 for UV-humidity and EN 15523:2001 for colour stability and requires minimum maintenance. PIGMENTO provides a special resilience in a marine environment and makes the removal of salt deposits easier than on the regular surfaces of other zinc finishes. PIGMENTO is available in four standard colours: PIGMENTO blue, green, brown, and red.

VMZINC is not a painted product and therefore colour variations may occur. No colour matches are guaranteed therefore zinc should be installed from the same roll/batch because of colour variations in the manufacturing process.

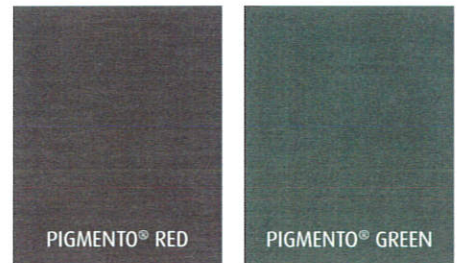
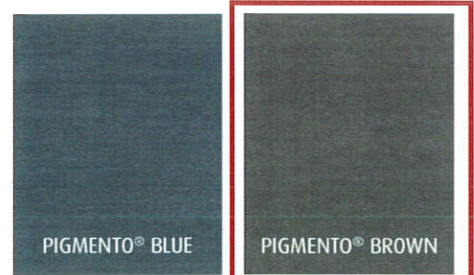
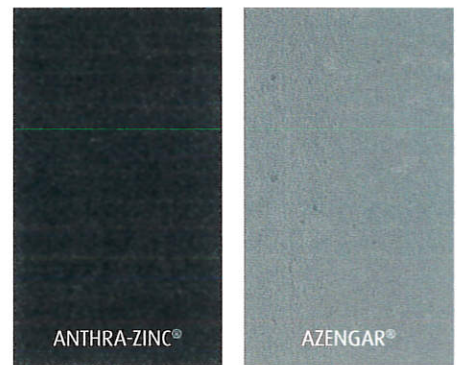
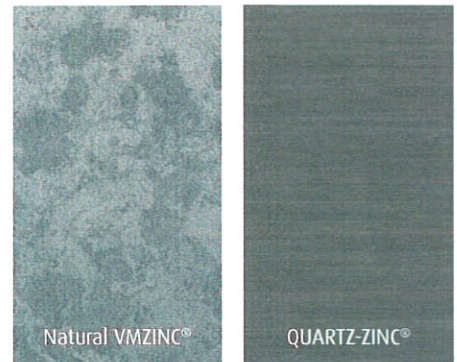

| | |
|---|--|
|  <p>CARLOS ZUBIETA ARCHITECTS</p> | <p>PROJECT ADDRESS:</p> <p>199 ARBOR LANE, MOSS BEACH, SAN MATEO COUNTY, CA</p> |
| | <p>TRIM</p> <p style="text-align: right;">PAGE 20</p> |

Compatibility with other materials

Important considerations

When placed in contact with zinc, certain products can have detrimental effects on the appearance and/or structural integrity of the zinc. Acidic products and products that can generate a galvanic reaction must not be used with zinc. Run-off from non compatible products onto zinc also must be avoided. In general, products with a pH lower than 5 and higher than 7 are not compatible with zinc.

There are no issues with zinc in combination with metals other than copper and mild steel. When zinc is in contact with copper in the presence of an electrolyte (such as water) a galvanic reaction will lead to corrosion of the zinc and subsequent failure of the roof or wall cladding.

Run-off from a copper surface to a zinc surface must be avoided under all circumstances. Zinc in contact with mild (carbon) steel is not desirable either, due to similar electron transfers between the metal that will result in zinc corrosion and deterioration.

Zinc can be installed adjacent to limestone. The run-off from limestone onto zinc material is acceptable. However, limestone dust and gypsum dust generated during cutting operations can react with zinc in the presence of water and form a superficial layer of white rust. No dust should be in contact with unprotected zinc. To prevent white rust, good construction practices should be used to limit the amount of dust that comes in contact with the zinc.



| Compatible contact products | |
|---------------------------------------|--|
| Metals | |
| Lead | |
| Aluminium (painted, anodised or bare) | |
| Galvanised steel | |
| Stainless steel | |
| Woods | |
| Pine | |
| Spruce | |
| Scots pine | |
| Poplar | |
| Miscellaneous materials | |
| Polyurethane | |
| Non-acetic silicones | |
| MS polymer mastics | |
| Organic timber treatments | |

| Incompatible contact products & run-off** | |
|---|--|
| Metals | |
| Copper | |
| Steel (non-galvanised) | |
| Gypsum dust/limestone dust | |
| Woods | |
| Larch | |
| Oak | |
| Chestnut | |
| Red cedar | |
| Douglas fir | |
| White cedar | |
| All woods with a pH < 5 | |
| Miscellaneous materials | |
| Mortar | |
| Building paper | |
| Bituminous membranes | |
| Fire retardant & preservative treatments | |
| Acidic cleaners (brick cleaner etc) | |
| Acetic silicones | |
| Metal salt timber treatments | |

** This list is not exhaustive

Zinc in different environments

Aesthetics Zinc has been installed all around the world and in all types of climates ranging from coastal Scotland, the deserts of Arizona, tropical Singapore, the high mountains of Switzerland and even near the cliffs of Cape Horn, to name but a few locations.

Hot, cold, wet, dry, windy, coastal, rural and urban climates are all environments where zinc has been installed.

As well as the almost endless variety of environments where zinc can be, and has been used, zinc is a material that requires almost no maintenance as the rinsing effect of rainwater performs this task naturally. However, when zinc is used on a non-rinsed surface such as a protected facade or soffit it is possible that the zinc may exhibit some superficial stains. These stains will not affect the integrity of the zinc itself.

It is for this reason that the very dark grey ANTHRA-ZINC should be carefully considered before being designed on a non-rinsed facade or soffit. In marine locations (1km from the sea) the risk of superficial staining in these areas increases.

Staining on non-rinsed surfaces will decrease further away from the sea. However, salt can still be present in the air up to 20km from the sea.

Whilst stains are possible on the PIGMENTO range the visual effect is greatly reduced and therefore these finishes may be more appropriate for some specific locations. It should be noted that the PIGMENTO must not be left with bare edges exposed in marine locations, and folding radii must be respected.

When QUARTZ-ZINC is installed on a roof just prior to snowfall and the snow lies on the zinc for several weeks it is possible that some superficial stains can be left visible following the eventual snow melt. These stains will not affect the integrity of the zinc and will in time fade due to the rinsing effect of rainwater.

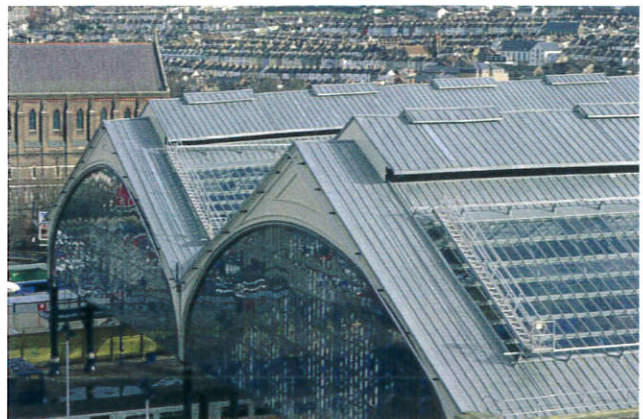

Sustainable performance

Low energy used in the manufacturing process

VMZINC rolled zinc products are used in construction industries throughout the world for their sustainability, distinctive appearance, and low maintenance requirements. As with VMZINC facade and rainwater systems, manufacturing processes for our standing seam system presents a low environmental impact, particularly with regard to energy expenditure.

As the comparative energy expenditure diagram opposite shows, less energy is required to extract zinc from the ground than the other principal metals, and is even more favourable for recycled zinc. Such minimal use of energy in the production of zinc clearly indicates its contribution to sustainable development.

Recycled material

95% of old rolled zinc recovered every year in Western Europe, currently estimated at 100,000 tonnes, is reused. This represents savings in mining resources of between 1 and 2 million tonnes.

Low corrosion, long life

The VMZINC standing seam system benefits from zinc's self-protecting patina which develops as a result of exposure to water and carbon dioxide. Over the last 50 years the quantity of sulphur dioxide in the atmosphere has been greatly reduced. SO₂ being the key agent of corrosion means that corrosion rates are now 1µm per year. With an initial thickness of 0.7mm, the estimated life span of rolled zinc is over a hundred years.

A natural material

VMZINC undertakes Life Cycle Analysis (LCA) tests on its products and publishes Environmental Product Declarations (EPDs), such as BRE Environmental Profiles, available from our website www.vmpzinc.co.uk and www.greenbooklive.com. These provide users with comprehensive, reliable and transparent information on relevant environmental characteristics. The information is also used by VMZINC as the basis for its eco-design approach.

Comparative energy expenditure in manufacture

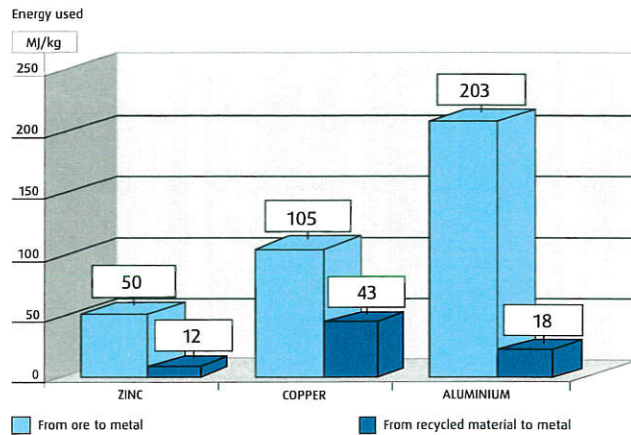

Compared with other metals, very little energy is needed to manufacture zinc metal from ore – less than half the consumption of copper and stainless steel and less than a quarter of that used for aluminium. CO₂ and other greenhouse gas emissions are also, therefore, proportionally less.



Sustainable performance



BRE Environmental profiles measure the impacts of a construction material, product or building system throughout its life, not only during its manufacture, but also its use in a building over an 80-year period. This includes its extraction, processing, use and maintenance and its eventual disposal.

VMZINC has been audited and reviewed by BRE Global. The Life Cycle Assessment (LCA) modelling derives a Certified Environmental Profile and a Green Guide rating has been produced.

A wide range of zinc roofing and cladding systems has been audited with the systems receiving Green Guide ratings of **A** and **A+**. These profiles can then be applied to the BREEAM (BRE Environmental Assessment Method) allowing VMZINC to contribute to schemes such as the Code for Sustainable Homes.



OHSAS 18001 Since 2009, VMZINC has been OHSAS 18001 certified, thus conforming to occupational health and safety management systems.



ISO 14001 VMZINC manufacturing plants have conformed to ISO 14001 since 2004/5 so processes are strictly controlled to ensure that emissions are significantly below the national regulation threshold.



ISO 9001 ISO 9001 is the internationally recognised standard for the quality management of businesses and applies to all Umicore/VMZINC products and services. Certification was originally obtained in 1997 and updated in November 2003 to conform to ISO 9001: 2000.



SPECIFICATIONS

DESCRIPTION:

Sleek square LED path light. Suitable for wet/damp/dry location installations.

MATERIAL:

Standard overall material is 6061 aluminum.

FINISH:

- AA - Anodized Satin Aluminum
- AP - Powder Coat Aluminum
- BK - Powder Coat Black
- BZ - Powder Coat Bronze
- WT - Powder Coat White

LED OPTIONS:

Integral high output LED, warm white (3000K CCT) standard, others available. LED is MLV dimmable.

- 3LED - 3W LED
- 8LED - 8W LED

VOLTAGE:

12 - 12 VAC output transformer required, not included.

MOUNTING:

Fixtures mount directly to standard Hevi Lite ground mounts with 1/2-NPS thread. Fixtures with stem extensions mount directly to wood or concrete surfaces. Stem extensions are equipped with wiring compartment, (1) opening for 1/2" conduit or 1/2-NPS mount and (4) 1/4" holes for concrete anchors.

- GM-1 - Composit mounting spike
- GM-2 - Cast mounting spike.
- GM-3 - Stainless steel triple prong spike.
- GM-4 - Stainless steel triple prong spike w/j-box
- GM-5 - ABS mounting spike w/ wiring compartment
- GM-6 - Cast mounting spike with wiring box
- GM-7 - Cork screw style mounting spike
- GM-8 - Cast in grade j-box
- GM-9 - Landscape power post

SIZES:

Standard fixture height is 12". Four standard stem extension available, custom lengths available upon request.

- 12 - 12" Overall Length
- 15 - 15" Overall Length
- 18 - 18" Overall Length
- 24 - 24" Overall Length
- 30 - 30" Overall Length

SAMPLE ORDER SPECIFICATION:

HL-6500-BZ-8LED-12-12

RATING:

Wet/damp/dry location.

MADE IN THE USA

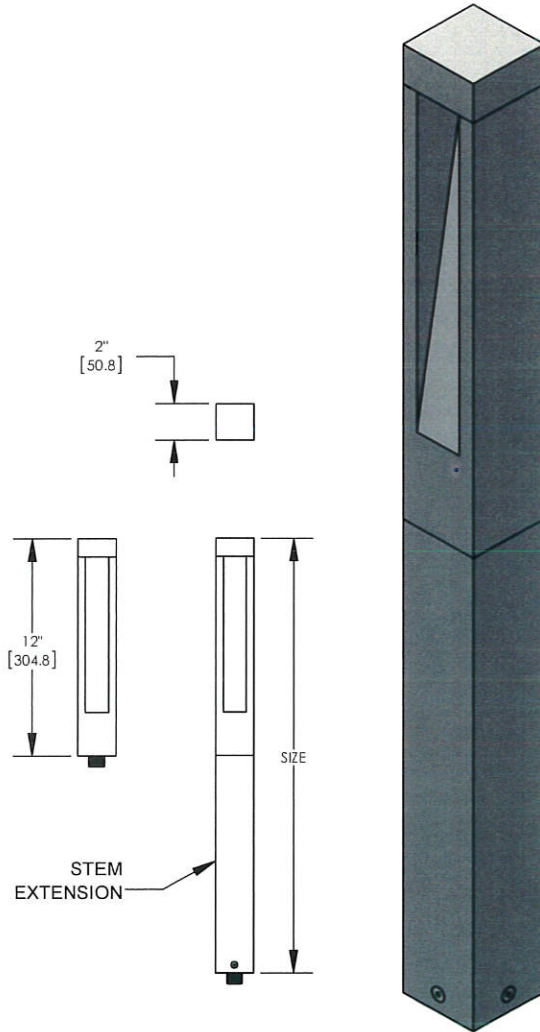

ORDER SPECIFICATION: _____
Fixture Finish Optics Voltage Options/Access.

PROJECT:

APPROVED:

NOTE:

TYPE:

HEVI LITE, INC.

9714 Variel Ave, Chatsworth, CA 91311
 Tel., (818) 341-8091 - Fax (818) 998-1986
 Web Site <http://www.hevilite.com>

CATALOG NUMBER:

HL-6500

THE INFORMATION CONTAINED IN THIS DRAWING IS THE SOLE PROPERTY OF HEVI LITE, INC. ANY REPRODUCTION IN PART OR WHOLE WITHOUT THE WRITTEN PERMISSION OF HEVI LITE, INC. IS PROHIBITED.



CARLOS ZUBIETA ARCHITECTS

PROJECT ADDRESS:

199 ARBOR LANE, MOSS BEACH, SAN MATEO COUNTY, CA

LANDSCAPE LIGHTING

PAGE 25

IP65 : Suitable for Wet Locations
IK08 : Impact Resistant (Vandal Resistant)



UGI-31591 Gino 2 frosted diffuser LED

Wall mounted luminaires with upward and downward light distributions. Ideally suited to illuminate the wall and surfaces in front of wall and for light accents on vertical surfaces using halogen main voltage or compact fluorescent lamps.

Low copper content corrosion resistant die-cast aluminum frame and body. Stainless steel screws. Durable silicone rubber gasket and impact resistant toughened glass diffuser. The luminaire is treated with a chemical chromated protection before powder coating, ensuring high corrosion resistance. Integral control gear. Anodized high purity 95% reflective aluminum reflector. As an option the glass lens can be lightly frosted to hide lamp image. The Gino can also be supplied in a LED version. Fixture mounts over a 3" octagonal junction box.

Physical Data

Length: 3.94"
Height: 3.91"
Weight: 2.2 lbs

Lamp

4w - 135lm - White - LED

LED Color (Please Specify)

W27 - 2700K
 W30 - 3000K
 W40 - 4000K

Voltage (Please Specify)

120/277v
 Other _____

Color (Please Specify)

01-Black - RAL 9011 02- Dark Grey - RAL 7043
 03-White - RAL 9003 04 - Metallic Silver - RAL 9006
 05-Matt Silver - RAL 9006 07- Custom - RAL _____
 06-Bronze - RAL 6014



Options (Please Specify)

F - Frosted Lens
 C - Clear Lens

Spike Beam (Optional)

Single Spike

Mounting Detail (Please Specify)

3" Mounting Plate
 4" Mounting Plate

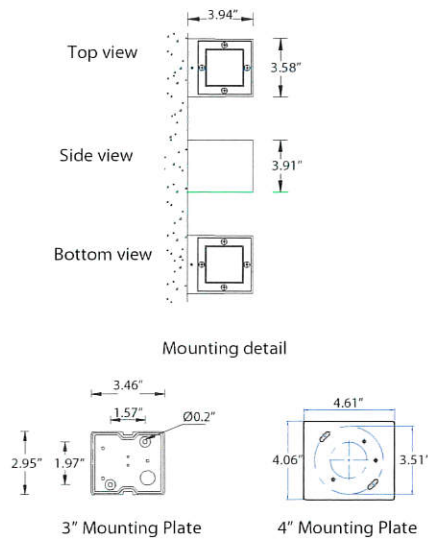

Single Spike

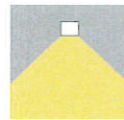

Ordering Example : UGI - 31591 - White-4w - W30 - 120v - Options



Rev: 11/13

PROJECT: _____ DATE: _____

TYPE: _____ QUANTITY: _____ NOTE: _____

Ligman Lighting USA reserves the right to change specifications without prior notice, please contact factory for latest information.
Due to the continual improvements in LED technology data and components may change without notice.



Flex Tube SC

| | |
|-------------|--|
| Client: | |
| Project: | |
| Type: | |
| Order Code: | |
| Quantity: | |



Flex Tube SC is a single color, outdoor rated, flexible LED tube. It features a bend diameter of as little as 4.8", can be cut to length every 4", and features an IP68, submersible rating, suitable for any exterior application. It is sold in spools of 32' (10m), and is, impact, UV, and saltwater resistant.

SPECIFICATIONS

| | |
|----------------------------------|---|
| Color | 2700K, 3000K, 3500K, 4000K, Red, Green, Blue |
| Beam Angle | 160° |
| Max Fixture Runs | 32' (10m) |
| Power Consumption | 3.75W Per Foot, 120W per 32' (10m) Spool |
| Lumens Per Foot | 120 |
| Cut & Connect Joints | Located Every 4" |
| Housing | UV Coated, Flexible PVC Jacket + Silicone Top |
| Installation Temperature | 32°F to 113°F (-0°C to 45°C) |
| Operating Temperature | -40°F to 131°F (-40°C to 55°C) |
| Operating Voltage | 24VDC |
| Dimming | via DMX-512, 1 Channel Per Spool / Section |
| Connectors & Hardware | All Accessories Sold Separately Including First Cables and End Caps, See Page 2 |
| Ingress Protection | IP 68, Wet Location / Submersible Up To 10' (3m) |
| Impact Resistance | IK 08, Up 5 Joule Impact Energy Protection |
| Warranty | 3 Years |
| Weight | 7.6 lbs (3.5 kg) |
| Dimensions | W 0.5" x H 0.81" x L 32.8' (12.7 mm x 20.6 mm x 10m) |

Certifications



DIMENSIONS

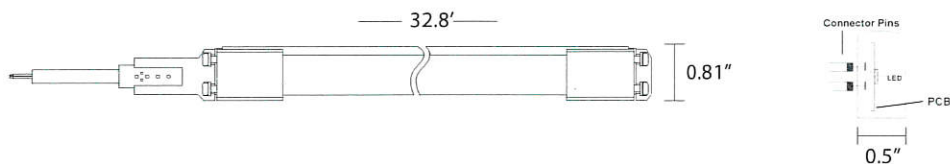

Material Safety Data Sheet

GRANITE

*****Section 1- Chemical Products and Company Identification*****

Chemical Name: Granite
 Trade Name: Crushed Stone
 Synonyms: Aggregate, Manufactured Sand
 Chemical Formula: None
 Molecular Wt.: N/A
 DOT I.D. #: None

*****Section 2- Product and Component Data*****

| CAS # | Component | Percent |
|-------|-----------|---------|
| None | Granite | |

Composition varies naturally typically contains quartz (crystalline silica) 14808-60-7

*****Section 3- Physical Data*****

Appearance and Odor: Angular particles, light salt-and-pepper Ranging in size from pebbles to boulders.
 No odor

Boiling Point (At 1 Atm): Not applicable

Vapor Pressure (mm Hg@20°C): Not applicable

Evaporation rate: @1 ATM & 25°C; n-butyl acetate = 1

Specific Gravity: 2.6-2.81

Vapor Density in Air (Air = 1): Not applicable

% Volatile, by Volume @ 100°F: 0%

Issue Date: 01/14/07

1 of 5

| | |
|---|--|
|  | <p>PROJECT ADDRESS: 199 ARBOR LANE, MOSS BEACH, SAN MATEO COUNTY, CA</p> |
| | <p>ROOFING - GRANITE #5 - 1/4" : TYPE A</p> |

Material Name: Granite

Section 4- Reactivity Data

Stability: Stable

Conditions to Avoid: Avoid contact with incompatible materials.

Incompatibility (Materials to avoid): Contact with powerful oxidizing agents such as fluorine, boron trifluoride, chlorine trifluoride, manganese trifluoride, and oxygen difluoride may cause fire and/or explosions. Silica dissolves readily in hydrofluoric acid producing a corrosive gas-silicon tetra fluoride.

Hazardous Decomposition Products: handling may generate silica-containing respirable dust particles.

Hazardous Polymerization: Not known to polymerize.

Section 5- Fire and Explosion Data

Flashpoint (Method used):

Not flammable.

Flammable Limits in Air

Not Flammable.

Extinguishing Agents

None required.

Unusual Fire and Explosion Hazards

Contact with powerful oxidizing agents may cause fire and/or explosions.

Section 6- Toxicity and First Aid

Exposure Limits (when exposure to this products and other chemicals is concurrent, the exposure limit must be defined in the workplace).

Unless specified otherwise, limits are expressed as eight-hour time-weighted averages (TWA) Limits for cristobalite and tridymite (other forms of crystalline silica) are equal to one-half of the limits for quartz.

Abbreviations:

TLV=threshold limit value of the American Conference of Governmental Hygienists (ACGIH)

MSHA PEL = permissible exposure limits of the Occupational Safety and Health Administration (OSHA); mg/m³ (respirable particulate not otherwise regulated).

Respirable Crystalline Silica (quartz): TLV = 0.5 mg/m: MSHA and OSHA PEL = 10mg/m³ ÷ (%SiO₂): MSHA Proposed and OSHA Proposed PEL = 0.1 mg/m³

Respirable Dust: MSHA and OSHA PEL = 10mg/m³ ÷ (%SiO₂)

Total Dust: MSHA PEL = 30 mg/m³ ÷ (%SiO₂); OSHA PEL = 30 mg/m³ ÷ (%SiO₂)

Material Name: Granite

ACGIH, MSHA, and OSHA have determined that adverse effects are not likely to occur in the workplace provided exposure levels do not exceed the appropriate TLVs/PELs. However, because of the wide variation in individual susceptibility, lower exposure limits may be appropriate for some individuals including persons with pre-existing medical conditions such as those described below.

Medical Conditions Aggravated by Exposure: Inhaling respirable dust may aggravate existing respiratory system disease(s) and/or dysfunctions. Exposure to dust may aggravate existing skin and/or eye conditions.

Primary Route(s) of Exposure: Inhalation

Eye Contact: Direct contact with dust may cause irritation by mechanical abrasion.

Skin Absorption: Not expected to be significant exposure route.

Ingestion: Expected to be practically non-toxic. Ingestion of large amounts may cause gastrointestinal irritation and blockage.

Inhalation: Dusts may irritate the nose, throat, and respiratory tract by mechanical abrasion. Coughing, sneezing, and shortness of breath may occur following exposures in excess of appropriate exposure limits.

Use of granite for construction purpose is not believed to cause additional acute toxic effects. However, repeated overexposure to very high levels of respirable crystalline silica (quartz, cristobalite, tridymite) for periods as short as six month have acute silicosis. Acute silicosis is a rapidly progressive, incurable lung disease that is typically fatal. Symptoms include, but not limited to shortness of breath, cough, fever, weight loss, and chest pain.

| |
|-----------------------------------|
| ***Section 7- First Aid*** |
|-----------------------------------|

Eyes: Immediate flush eye(s) with plenty of clean water for at least 15 minutes, while holding eyelid(s) to ensure thorough rinsing. Beyond flushing, do not attempt to remove material from the eye(s). Contact a physician if irritation persists or later develops.

Ingestion: If person is conscious, give large quantity of water and induce vomiting; however, never attempt to make an unconscious person drink or vomit.

Chronic toxicity: Prolonged and repeated inhalation or respirable crystalline silica containing dust in excess of appropriate exposure limits has caused silicosis, a lung disease. Not all individuals with silicosis will exhibit symptoms (signs) of the disease. However, silicosis can be progressive, and symptoms of silicosis may include, but are not limited to, the following; shortness of breath; difficulty breathing with or without exertion; coughing; diminished work capacity; diminished chest expansion; reduction of lung volume; right heart enlargement and/or failure. Smoking may increase the risk of developing lung disorders, including emphysema and lung cancer. Persons with silicosis have an increased risk of tuberculosis infection.

Respirable dust containing newly broken silica particles has been to be hazardous to animals in laboratory tests that respirable dust containing older silica particles of similar size. Respirable silica particles, which had aged for sixty days or more showed less lung injury in animals than equal exposure of respirable dust containing newly broken particles of silica.

Material Name: Granite

There are reports in the literature suggesting that excessive crystalline silica exposure may be associated with adverse health effect involving the kidney, scleroderma (thickening of the skin caused by swelling and the thickening of fibrous tissue) other autoimmune disorders. However, this evidence has been obtained primarily from case reports involving individuals working in high exposure situations or those who have already developed silicosis; and therefore, this evidence does not conclusively prove a casual relationship between silica or silicosis and these adverse health effects. Several studies on people with silicosis also indicated an increased risk of developing lung cancer, a risk that increases with the duration of exposure. Many of these studies do not account for lung cancer confounders, especially smoking.

Granite is not listed as a carcinogen by the International Agency for Research on Cancer (IARC), the National Toxicology Program (NTP), or the Occupational Safety and Health Administration (OSHA). In October 1996, IARC Working Group re-assessing crystalline silica, a component of this product, designed respirable crystalline silica as carcinogenic (group1). The NTP's Report of Carcinogens, 9th edition, lists respirable crystalline silica as a "known human carcinogen." In year 2000, the American Conference of Governmental Industrial Hygienists (ACGIH) listed respirable crystalline Silica (quartz) as a suspected human carcinogen (A-2). These classifications are based on sufficient evidence of carcinogenicity in certain experimental animals and on selected Epidemiological studies of workers exposed to crystalline silica.

California Proposition 65

WARNING: This product contains chemical(s) known to the State of California to cause cancer.

*****Section 8- Personal Protection and Controls*****

Respiratory Protection- For respirable quartz levels that exceed or are likely to Exceed an 8 hr TWA of 0.1 mg/m³, a NIOSH approved dust respirator must be worn. For respirable quartz levels that exceed or are likely to exceed 8hr-TWA of 0.5 mg/m³, a NIOSH approved HEPA filter respirator must be worn. If respirable quartz levels exceed or are likely to exceed an 8hr TWA of 5 mg/m³, a NIOSH approved positive pressure, full-face respirator or equivalent is required. Respirator use must comply with applicable MSHA or OSHA standards, which include provisions for a user training program, respirator repair and cleaning, respirator for testing and other requirements.

Ventilation: Local exhaust or general ventilation adequate to maintain exposure below appropriate exposure limits.

Skin Protection: See "Hygiene" section below.

Eye Protection: Safety glasses with side shields should be worn as minimum protection. Dust goggles should be worn when excessively (visible) dusty conditions are present or are anticipated.

Hygiene: Wash dust-exposed skin with soap and water before eating, drinking, smoking, and using toilet facilities. Wash work clothes after each use.

Other Control Measures: Respirable dust and quartz levels in excess of appropriate exposure limits should be reduced by all feasible engineering controls, including (but not limited to) wet suppression, ventilation. Process enclosure and enclosed employee work stations.

*****Section 9- Storage and Handling Precautions*****

Respirable crystalline silica-containing dust may be generated during processing, handling and storage. The personal protection and controls identified in Personal Protection and Controls section of the MSDS should be used as appropriate. Do not store near food and beverages or smoking materials.

Material Name: Granite

Spill, leak and Disposal Practices:

Steps to be taken in case materials is released or spilled- The personal protection and controls identified in Personal Protection and Controls section of the MSDS should be used as appropriate. Spilled materials, where dust can be generated, may overexpose cleanup personnel to respirable crystalline silica-containing dust. Wetting of spilled material and/or use of respiratory protective equipment may be necessary. Do not dry sweep-spilled material.

Prevent spilled materials from inadvertently entering streams, drains, or sewers.

Waste Disposal Method- Disposal of waste materials only in accordance with applicable federal, state, and local laws and regulations.

Transportation

DOT Hazard Classification-None

Placard Required- None

Label Required-Label as required by the OSHA Hazards Communication Standard [29CFR 1901.1200(f) and applicable state and local laws and regulations.

No warranty is made, express or implied, or merchantability, fitness for Particular purpose or otherwise.

SPECIFICATIONS

DESCRIPTION:

Sleek square LED path light. Suitable for wet/damp/dry location installations.

MATERIAL:

Standard overall material is 6061 aluminum.

FINISH:

- AA - Anodized Satin Aluminum
- AP - Powder Coat Aluminum
- BK - Powder Coat Black
- BZ - Powder Coat Bronze
- WT - Powder Coat White

LED OPTIONS:

Integral high output LED, warm white (3000K CCT) standard, others available. LED is MLV dimmable.

- 3LED - 3W LED
- 8LED - 8W LED

VOLTAGE:

12 - 12 VAC output transformer required, not included.

MOUNTING:

Fixtures mount directly to standard Hevi Lite ground mounts with 1/2-NPS thread. Fixtures with stem extensions mount directly to wood or concrete surfaces. Stem extensions are equipped with wiring compartment, (1) opening for 1/2" conduit or 1/2-NPS mount and (4) 1/4" holes for concrete anchors.

- GM-1 - Composit mounting spike
- GM-2 - Cast mounting spike.
- GM-3 - Stainless steel triple prong spike.
- GM-4 - Stainless steel triple prong spike w/j-box
- GM-5 - ABS mounting spike w/ wiring compartment
- GM-6 - Cast mounting spike with wiring box
- GM-7 - Cork screw style mounting spike
- GM-8 - Cast in grade j-box
- GM-9 - Landscape power post

SIZES:

Standard fixture height is 12". Four standard stem extension available, custom lengths available upon request.

- 12 - 12" Overall Length
- 15 - 15" Overall Length
- 18 - 18" Overall Length
- 24 - 24" Overall Length
- 30 - 30" Overall Length

SAMPLE ORDER SPECIFICATION:

HL-6500-BZ-8LED-12-12

RATING:

Wet/damp/dry location.

MADE IN THE USA

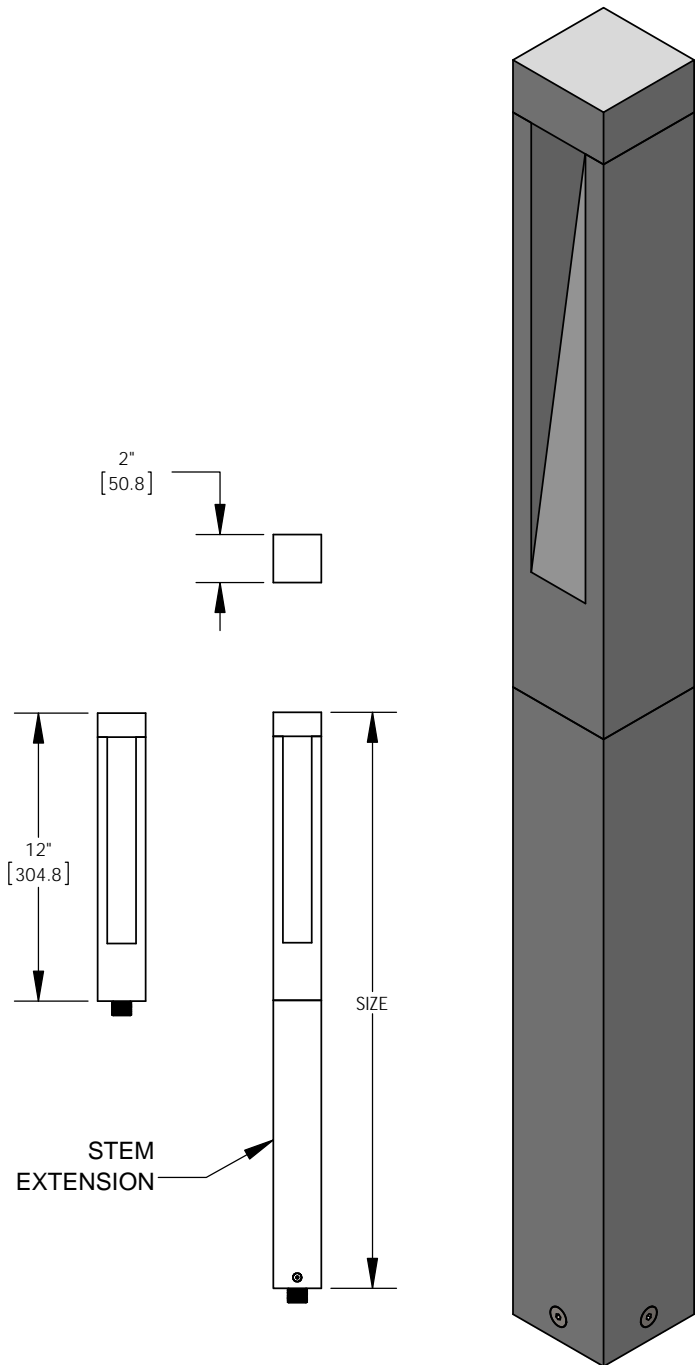

ORDER SPECIFICATION: _____ - _____ - _____ - _____ - _____
Fixture Finish Optics Voltage Options/Access.

PROJECT: _____
 APPROVED: _____
 NOTE: _____
 TYPE: _____

HEVI LITE, INC.
 9714 Variel Ave, Chatsworth, CA 91311
 Tel., (818) 341-8091 - Fax (818) 998-1986
 Web Site <http://www.hevilite.com>

CATALOG NUMBER:
HL-6500

SPECIFICATIONS

DESCRIPTION:

Sleek square LED path light with concrete mount. Suitable for wet/damp/dry location installations.

MATERIAL:

Standard overall material is 6061 aluminum.

FINISH:

- AA - Anodized Satin Aluminum
- AP - Powder Coat Aluminum
- BK - Powder Coat Black
- BZ - Powder Coat Bronze
- WT - Powder Coat White

LED OPTIONS:

Integral high output LED, warm white (3000K CCT) standard, others available. LED is MLV dimmable.

- 3LED - 3W LED
- 8LED - 8W LED

VOLTAGE:

12 - 12 VAC output transformer required, not included.

MOUNTING:

Fixtures mount directly to wood or concrete surfaces. Stem extensions are equipped with wiring compartment, (1) opening for 1/2" conduit and (4) 1/4" holes for concrete anchors.

SIZES:

Four standard stem extension available, custom lengths available upon request.

- 15 - 15" Overall Length
- 18 - 18" Overall Length
- 24 - 24" Overall Length
- 30 - 30" Overall Length

SAMPLE ORDER SPECIFICATION:

HL-6500-CM-BZ-8LED-12-24

RATING:

Wet/damp/dry location.

MADE IN THE USA

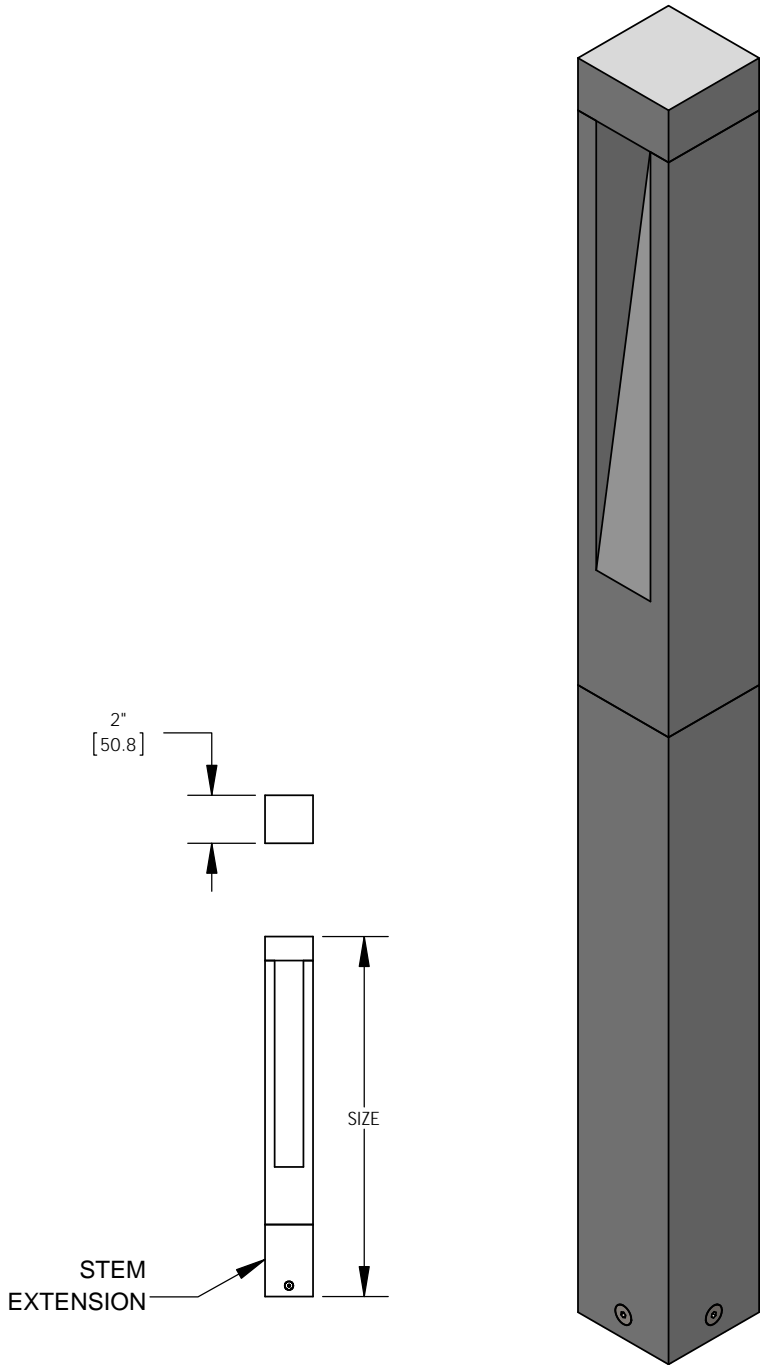

ORDER SPECIFICATION: _____ - _____ - _____ - _____ - _____
Fixture Finish Optics Voltage Options/Access.

PROJECT: _____
 APPROVED: _____
 NOTE: _____
 TYPE: _____

H HEVI LITE, INC.
 9714 Variel Ave, Chatsworth, CA 91311
 Tel., (818) 341-8091 - Fax (818) 998-1986
 Web Site <http://www.hevilite.com>

CATALOG NUMBER:
HL-6500-CM

IP65 : Suitable for Wet Locations
 IK08 : Impact Resistant (Vandal Resistant)

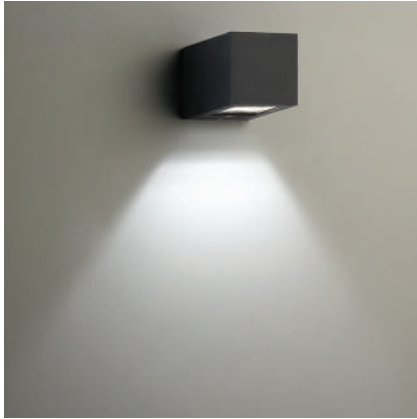

UGI-31591 Gino 2 frosted diffuser LED

Wall mounted luminaires with upward and downward light distributions. Ideally suited to illuminate the wall and surfaces in front of wall and for light accents on vertical surfaces using halogen main voltage or compact fluorescent lamps.

Low copper content corrosion resistant die-cast aluminum frame and body. Stainless steel screws. Durable silicone rubber gasket and impact resistant toughened glass diffuser. The luminaire is treated with a chemical chromated protection before powder coating, ensuring high corrosion resistance. Integral control gear. Anodized high purity 95% reflective aluminum reflector. As an option the glass lens can be lightly frosted to hide lamp image. The Gino can also be supplied in a LED version. Fixture mounts over a 3" octagonal junction box

Physical Data

Length: 3.94"
 Height: 3.91"
 Weight: 2.2 lbs

Lamp

4w - 135lm - White - LED

LED Color (Please Specify)

W27 - 2700K
 W30 - 3000K
 W40 - 4000K

Voltage (Please Specify)

120/277v
 Other _____

Color (Please Specify)

01-Black - RAL 9011 02- Dark Grey - RAL 7043
 03-White - RAL 9003 04 - Metallic Silver - RAL 9006
 05-Matt Silver - RAL 9006 07- Custom - RAL _____
 06-Bronze - RAL 6014

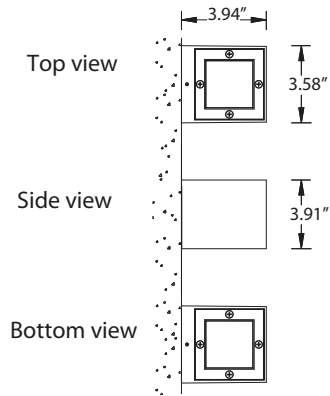

Mounting detail

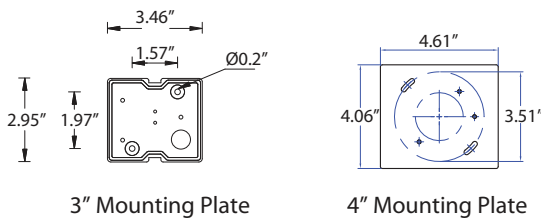

Options (Please Specify)

F - Frosted Lens
 C - Clear Lens

Spike Beam (Optional)

Single Spike

Mounting Detail (Please Specify)

3" Mounting Plate
 4" Mounting Plate

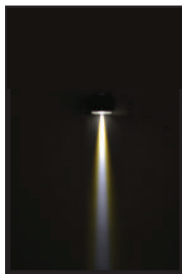

Single Spike

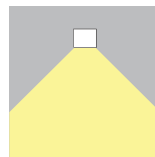

Ordering Example : UGI - 31591 - White-4w - W30 - 120v - Options



Rev: 11/13

PROJECT: _____ DATE: _____

TYPE: _____ QUANTITY: _____ NOTE: _____

Ligman Lighting USA reserves the right to change specifications without prior notice, please contact factory for latest information. Due to the continual improvements in LED technology data and components may change without notice.



Flex Tube SC

| | |
|-------------|--|
| Client: | |
| Project: | |
| Type: | |
| Order Code: | |
| Quantity: | |

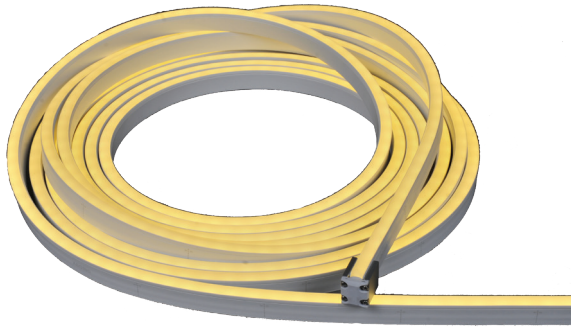

Flex Tube SC is a single color, outdoor rated, flexible LED tube. It features a bend diameter of as little as 4.8", can be cut to length every 4", and features an IP68, submersible rating, suitable for any exterior application. It is sold in spools of 32' (10m), and is, impact, UV, and saltwater resistant.

SPECIFICATIONS

| | |
|----------------------------------|---|
| Color | 2700K, 3000K, 3500K, 4000K, Red, Green, Blue |
| Beam Angle | 160° |
| Max Fixture Runs | 32' (10m) |
| Power Consumption | 3.75W Per Foot, 120W per 32' (10m) Spool |
| Lumens Per Foot | 120 |
| Cut & Connect Joints | Located Every 4" |
| Housing | UV Coated, Flexible PVC Jacket + Silicone Top |
| Installation Temperature | 32°F to 113°F (-0°C to 45°C) |
| Operating Temperature | -40°F to 131°F (-40°C to 55°C) |
| Operating Voltage | 24VDC |
| Dimming | via DMX-512, 1 Channel Per Spool / Section |
| Connectors & Hardware | All Accessories Sold Separately Including First Cables and End Caps, See Page 2 |
| Ingress Protection | IP 68, Wet Location / Submersible Up To 10' (3m) |
| Impact Resistance | IK 08, Up 5 Joule Impact Energy Protection |
| Warranty | 3 Years |
| Weight | 7.6 lbs (3.5 kg) |
| Dimensions | W 0.5" x H 0.81" x L 32.8' (12.7 mm x 20.6 mm x 10m) |

Certifications



DIMENSIONS

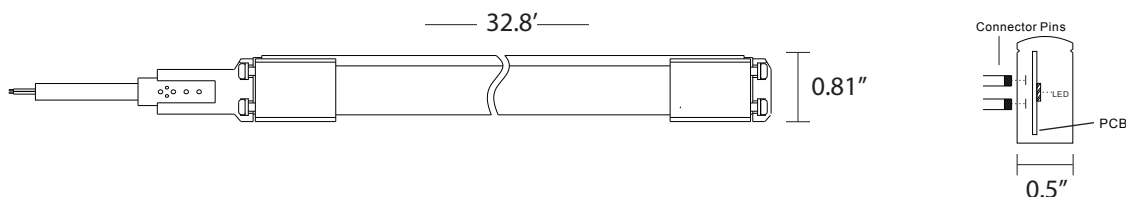

Flex Tube SC

| | |
|-------------|--|
| Client: | |
| Project: | |
| Type: | |
| Order Code: | |
| Quantity: | |

ORDER CODES (*Special Order Item)

FTB - 12 - AA - N

All Accessories Sold Separately Including First Cables and End Caps, See Below

- A** - 2700K*
- B** - 3000K
- D** - 3500K*
- E** - 4000K
- N** - Red*
- P** - Green*
- Q** - Blue

- 3** - Flex Tube SC 32.8' Spool (10m)
- 4*** - Flex Tube SC Injection Molded Side Mount Cable 32.8' Spool (10m)
- 5*** - Flex Tube SC Injection Molded Rear Mount Cable 32.8' Spool (10m)

RELATED COMPONENTS

| | |
|--------------------|---|
| APS-480-24 | Non-Dim 24VDC 480W 120/240V UL Din Rail Power Supply, Maximum Load - 3 x 10m Runs |
| APS-240-24 | Non-Dim 24VDC 240W 120/240V UL Din Rail Power Supply, Maximum Load - 1 x 10m Run |
| DPW-111-DA | AL Driver 8 RGBW 24V - 24V Power + DMX Driver, 120VAC or 240VAC Input / 1 Spool Maximum |
| AL-150-24 | Dry Location 24VDC 150W Transformer, 120 or 240VAC Input / 1 Spool Maximum for Non-Dim Use |
| CLG-150-24 | Wet Location 24VDC 150W Transformer, 120V-277VAC Input / 1 Spool Maximum for Non-Dim Use |
| FTUBESCFC | Flex Tube SC First Cable Kit (FTB Only) - IP68, 300mm (12"), Includes Gasket + Screws |
| FTUBESCLC | Flex Tube SC Link Cable (FTB Only) - IP68, 300mm (12"), Includes Gasket + Screws |
| FTUBESCMC | Flex Tube SC Seamless Mid Connector (FTB Only) |
| FTUBEEC | Flex Tube End Cap Kit - IP68, Includes Gasket + Screws |
| FTUBELCH1M | Flex Tube Self Lock Mounting Channel 1m (3.28') - Aluminum, Includes 3 Clasps + 4 Screws |
| FTUBELCH5CM | Flex Tube Self Lock Mounting Channel 5cm (2") - Aluminum, Includes 1 Clasp + 1 Screw |
| FTTK2 | Flex Tube Install Tool Kit - Includes Cutter, Insert Assist, and Carrying Case |

Flex Tube SC

| | |
|-------------|--|
| Client: | |
| Project: | |
| Type: | |
| Order Code: | |
| Quantity: | |

WIRING (DMX Dimming)

Maximum DC cable lengths - solid cable or higher, to be provided by others:

- 18/2 : 50' to each 32' run
- 14/2 : 120' to each 32' run
- 12/2 : 200' to each 32' run

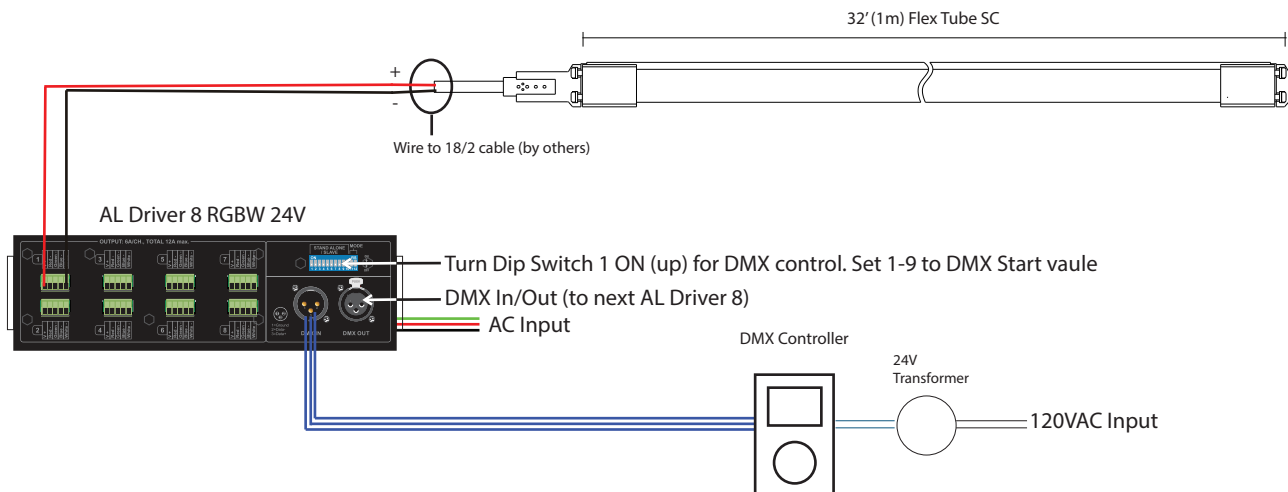

WIRING (Non-dim)

Maximum DC cable lengths - solid cable or higher, to be provided by others:

- 18/2 : 50' to each 32' run
- 14/2 : 120' to each 32' run
- 12/2 : 200' to each 32' run

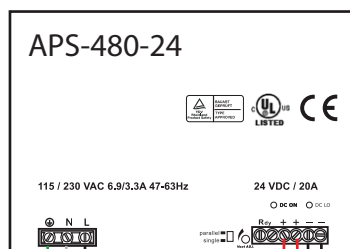

AC Input 120/240
Auto Switching

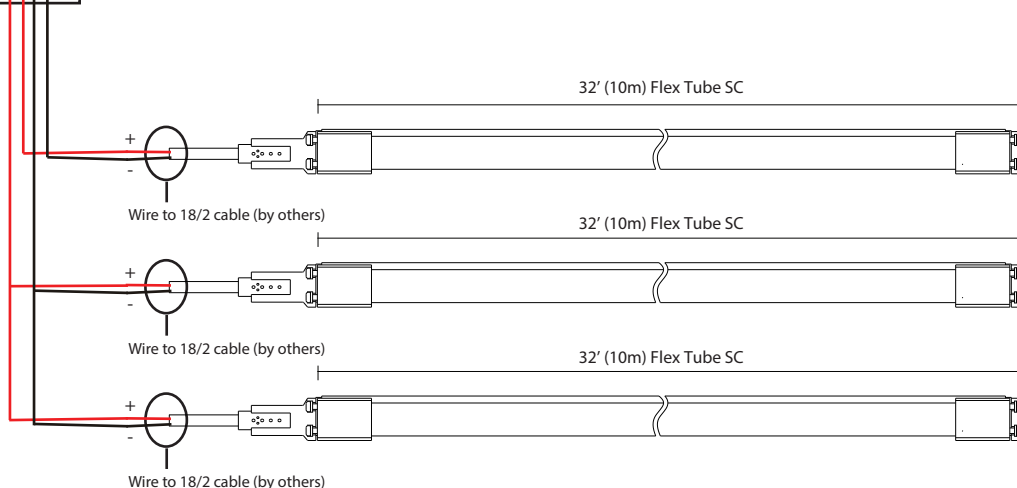

ARBOR RESIDENCE

199 ARBOR LANE MOSS BEACH, CA 94038

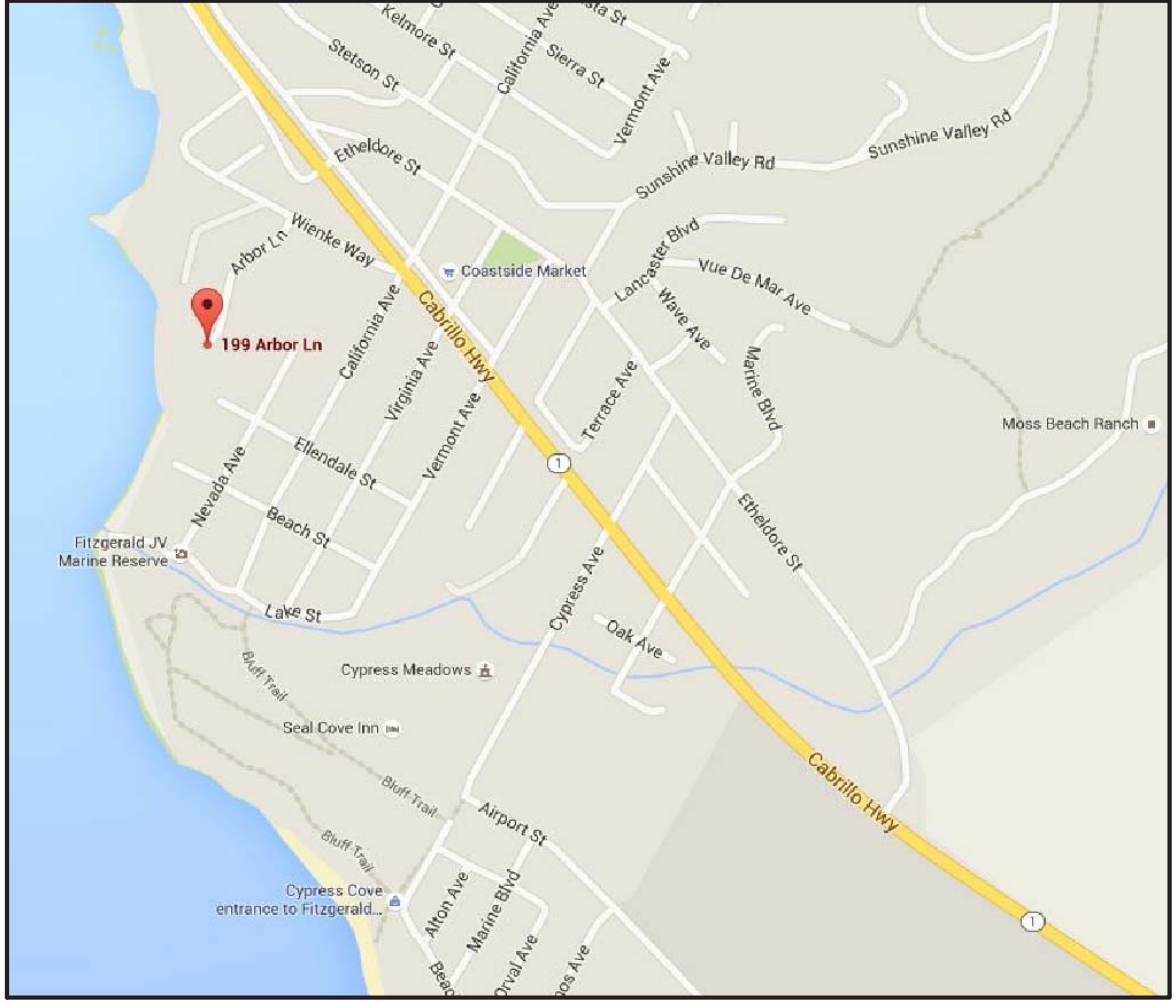
| PROJECT TEAM | SHEET INDEX | BUILDING ANALYSIS | VICINITY MAP | | | | | | | | |
|--|---|---|--------------|----------------|--|---------------|-----------|--------------|------------------------------------|---|---|
| <p>OWNER: ZUBAR LLC 1309 MAIN STREET VENICE, CA 90291</p> <p>ARCHITECT: CARLOS ZUBIETA ARCHITECTURE 310-827-8195 1725-A ABBOT KINNEY BLVD. VENICE, CA 90291</p> <p>SURVEYOR: LEA & BRAZE ENGINEERING INC 510-887-4086 26229 EDEN LANDING ROAD, SUITE 2 HAYWARD, CA 94545</p> <p>CIVIL ENGINEER: BERRY & ASSOCIATES 650-368-0750 1733 WOODSIDE ROAD, SUITE 335 REDWOOD CITY, CA 94061</p> <p>GEOTECHNICAL ENGINEER: MICHELUCCI & ASSOCIATES 650-692-0163 1801 MURCHISON DRIVE, SUITE 88 BURLINGAME, CA 94010</p> <p>BIOLOGICAL CONSULTANT: KOPITOV ENVIRONMENTAL LLC 206-456-4088 220 ATLANTIC AVE, SUITE 312 SANTA CRUZ, CA 95060</p> <p>STRUCTURAL ENGINEER: ---</p> | <p>ARCHITECTURAL SHEETS:</p> <p>A-0.0 COVER SHEET - INDEX - ZONING - VICINITY MAP PR-1.0 PROJECT DESCRIPTION + MATERIALS PR-1.1 EXTERIOR ELEVATIONS + MATERIALS PR-1.2 EXTERIOR ELEVATIONS + MATERIALS PR-1.3 BUILDING SECTIONS + MATERIALS PR-1.4 SURROUNDING NEIGHBORHOOD + ROOF TYPES SU-1.0 TOPOGRAPHIC SURVEY A-1.0 SITE PLAN A-3.0 FIRST FLOOR PLAN A-3.1 SECOND FLOOR PLAN A-3.2 ROOF PLAN LT-1.0 LIGHTING PLAN L-1.0 LANDSCAPE PLAN</p> <p>CIVIL SHEETS:</p> <p>C-1 SITE GRADING, DRAINAGE & UTILITY PLAN C-2 EROSION CONTROL PLAN C-3 BMPS</p> | <p>LEGAL DESCRIPTION:</p> <p>ADDRESS 199 ARBOR LANE MOSS BEACH, CA 94038</p> <p>LOT: 12 TRACT: TR 864 BLOCK: NONE ASSESSOR'S P.N⁹: 037-123-430 BUILDING CODE: 2017 EDITION OF CA BUILDING CODE</p> <p>PLANNING AND ZONING:</p> <p>OCCUPANCY TYPE: SINGLE FAMILY RESIDENTIAL ZONING: R-1/S-17/DR/CD EXISTING LAND USE: UNDEVELOPED PROPOSED BUILDING: SINGLE FAMILY RESIDENCE NUMBERS OF STORIES NEW BUILDING: 2 COASTAL DEVELOPMENT DISTRICT: YES DESIGN REVIEW DISTRICT: YES SCENIC VIEW CORRIDOR: YES</p> <p>BUILDING + LOT SUMMARY</p> <p>PARCEL AREA: 14,320 SF</p> <p>PROPOSED FLOOR AREA: FIRST FLOOR 2,611 SF SECOND FLOOR 908 SF TOTAL HABITABLE SF: 3,519 SF</p> <p>COVERED PORTION OF ENTRY PORCH 53 SF COVERED PORTION OF REAR PORCH 100 SF COVERAGE PORCHES 153 SF △</p> <p>2- CAR GARAGE 468 SF TOTAL BUILDING FLOOR AREA: 4,140 SF △</p> <p>PROPOSED BUILDING HEIGHT AT HIGHEST POINT: 26.89'</p> <p>BUILDING TO BE PROTECTED BY AN AUTOMATED FIRE SPRINKLER SYSTEM.</p> <p>SAN MATEO COUNTY ZONING REGULATIONS PER CHAPTER 20 SECTION 6300.2 FOR DISTRICT S-17:</p> <p>MAX ALLOWABLE HEIGHT (PER SECTION 6300.2.6) = 28.00'</p> <p>PARCEL COVERAGE FOR STRUCTURES > 16'-0" IN HEIGHT (PER SECTION 6300.2.4): 14,320 SF (LOT AREA) X .35 (35%) = 5,012 SF PROPOSED PARCEL COVERAGE = 4,208 SF △</p> <p>MAXIMUM BUILDING FLOOR AREA (PER SECTION 6300.2.5A): PARCEL SIZE OVER 11,698 SF = 6,200 SF PROPOSED BUILDING FLOOR AREA = 4,140 SF</p> <p>REQUIRED BUILDING SETBACKS (PER SECTION 6300.2.3):</p> <table style="width: 100%; border: none;"> <tr> <td style="width: 60%;"></td> <td style="text-align: right;">FRONT = 20'-0"</td> </tr> <tr> <td></td> <td style="text-align: right;">REAR = 20'-0"</td> </tr> <tr> <td>(MINIMUM)</td> <td style="text-align: right;">SIDE = 5'-0"</td> </tr> <tr> <td>(STRUCTURES OVER 16'-0" IN HEIGHT)</td> <td style="text-align: right;">SIDE = COMBINED TOTAL OF 15'-0" (MIN OF 5'-0" EACH SIDE)</td> </tr> </table> <p>MAXIMUM IMPERVIOUS SURFACE AREA (PER SECTION 6300.2.7): MAX PARCEL AREA COVERED BY IMPERVIOUS STRUCTURES LESS THAN 18" IN HEIGHT IS LIMITED TO 10% OF THE PARCEL AREA, BUT IS NOT TO EXCEED 1,170 SF FOR RESIDENTIAL USES. 10% OF 14,320 SF = 1,432 SF THEREFORE THE MAX IMPERVIOUS SURFACE AREA = 1,170 SF PROPOSED IMPERVIOUS SURFACE AREA = 1,098 SF</p> | | FRONT = 20'-0" | | REAR = 20'-0" | (MINIMUM) | SIDE = 5'-0" | (STRUCTURES OVER 16'-0" IN HEIGHT) | SIDE = COMBINED TOTAL OF 15'-0" (MIN OF 5'-0" EACH SIDE) |  |
| | FRONT = 20'-0" | | | | | | | | | | |
| | REAR = 20'-0" | | | | | | | | | | |
| (MINIMUM) | SIDE = 5'-0" | | | | | | | | | | |
| (STRUCTURES OVER 16'-0" IN HEIGHT) | SIDE = COMBINED TOTAL OF 15'-0" (MIN OF 5'-0" EACH SIDE) | | | | | | | | | | |



1 REVISIONS PER PLANNING SUBMITTAL COMMENTS 12-9-16

ASSESSOR'S PARCEL NUMBER:
037-123-430

PROJECT ADDRESS:
199 ARBOR LANE, MOSS BEACH, SAN MATEO COUNTY, CA

A-0.0

COVER SHEET



GOOGLE MAPS VIEW:

PROJECT LOCATION:

The project is located on a Cul-de sac approximately .17 miles West of Highway 1 in Moss Beach along the San Mateo County coastline. The coastal bluff is approximately 50 feet away from the property and overlooks the Fitzgerald Marine Reserve. The immediate surroundings of the project includes single family residences including one single family home to the immediate east and a vacant property owned by the home owners association to the North. The size of the site measures approximately 14,000 SF.

PROJECT DESCRIPTION:

The proposed project is of a new single family residence covering an estimated area of 3,500 square feet with an attached two car garage. The design and scale of the project was strategized to relate to the immediate neighborhood while the new structure uses contemporary strategies for incorporating passive solar, opening up the house to the outdoor spaces and retaining the native surrounding habitat as recommended by the biology report obtained. From the street the project scale is kept low to create visibility and reduce solid two-story wall surfaces.

The use of environmentally conscious materials throughout the house helps to emphasize the warmth and character as well as blend with the natural surrounding landscape. Western red cedar exterior walls, and warm plaster walls relate to the cliff, trees and vegetation. Large South facing windows will open to the views of the surrounding landscape while also providing passive solar heating within the home. Varying roof slopes allow the house to be nested into the low-lying neighborhood, while the granite on the exterior roofing reflects the rocks along the cliff.

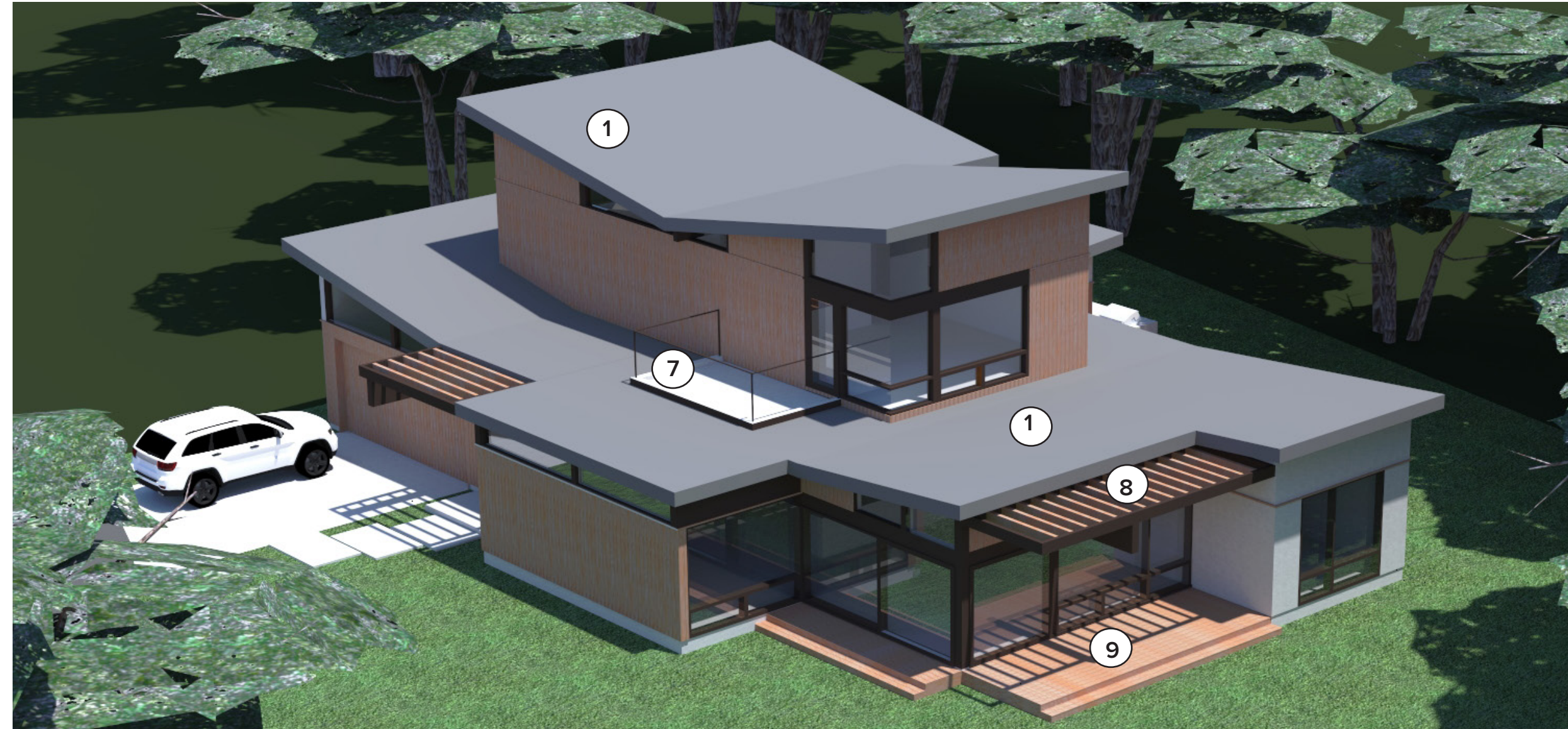

TOP VIEW:



NORTH ELEVATION VIEW: ARBOR LANE



SOUTH ELEVATION VIEW: OCEAN FACING

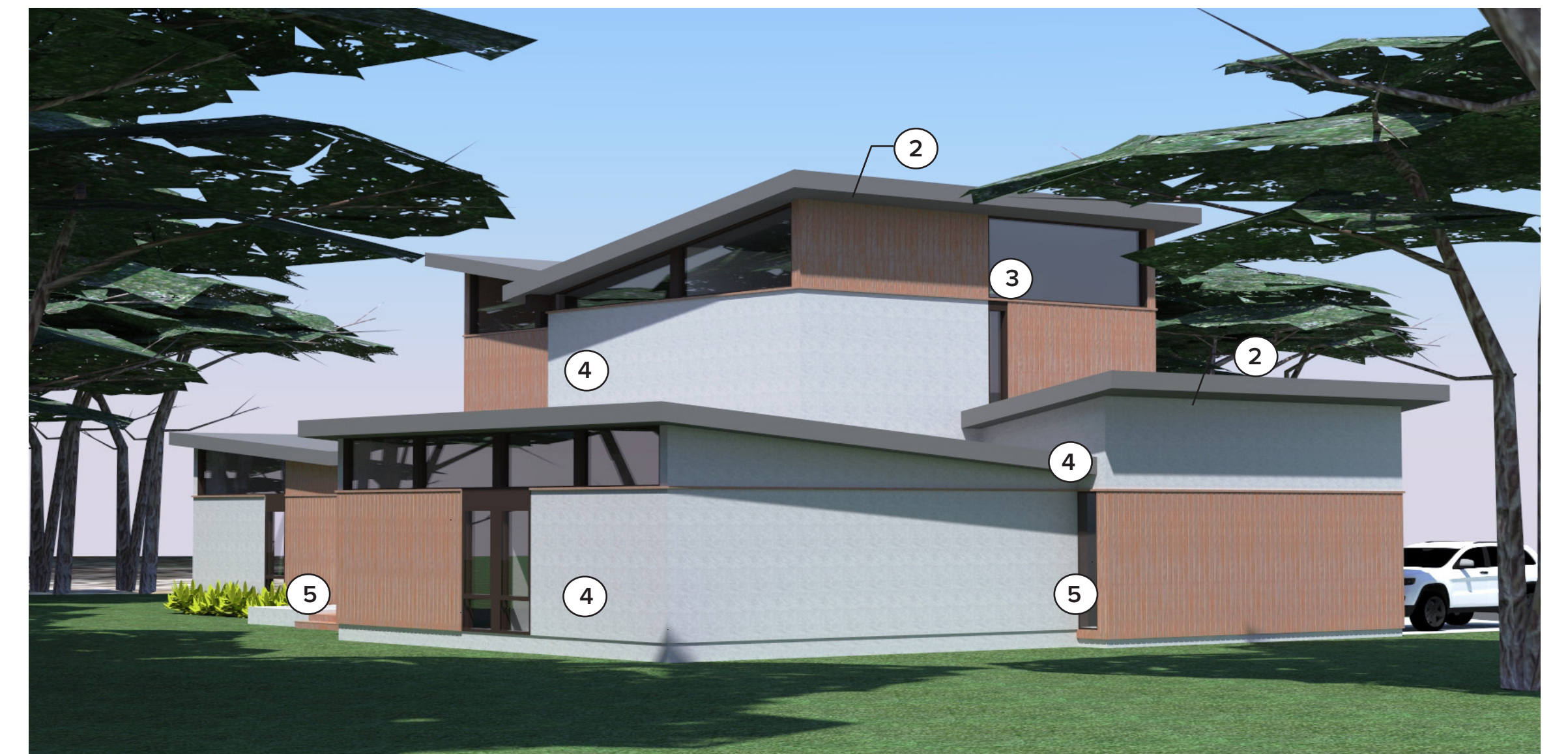

EAST ELEVATION VIEW:

MATERIALS AND FINISHES LEGEND:



1. ROOFING: Class A 4 Ply Built up roofing finished with a layer of rock - Granite No. 4 by A1 Grit Company

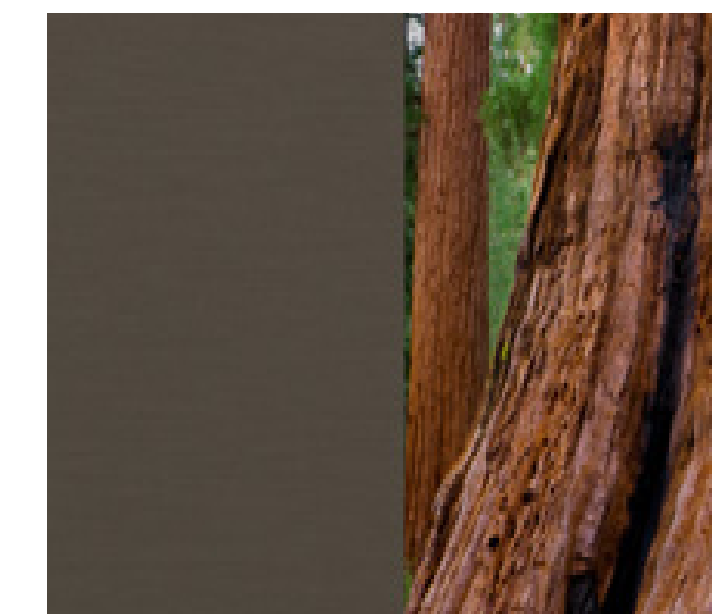

2. EXTERIOR TRIM: VM ZINC PIGMENTO zinc flat panels in "brown"



3. WINDOWS: Milgard Windows Aluminum Frame - color: dark bronze



4. EXTERIOR WALLS: Cement plaster La Habra integral color - smooth finish Color - "Charleston" - warm grey

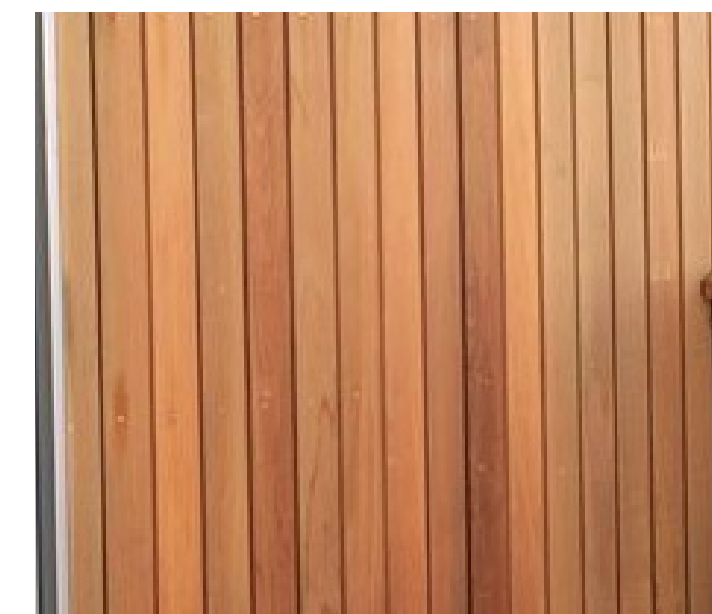

5. EXTERIOR WALLS: Natural wood siding in 4" wide - Western Red Cedar siding - Benjamin Moore ARBORCOAT waterborne exterior stain semi-solid 639

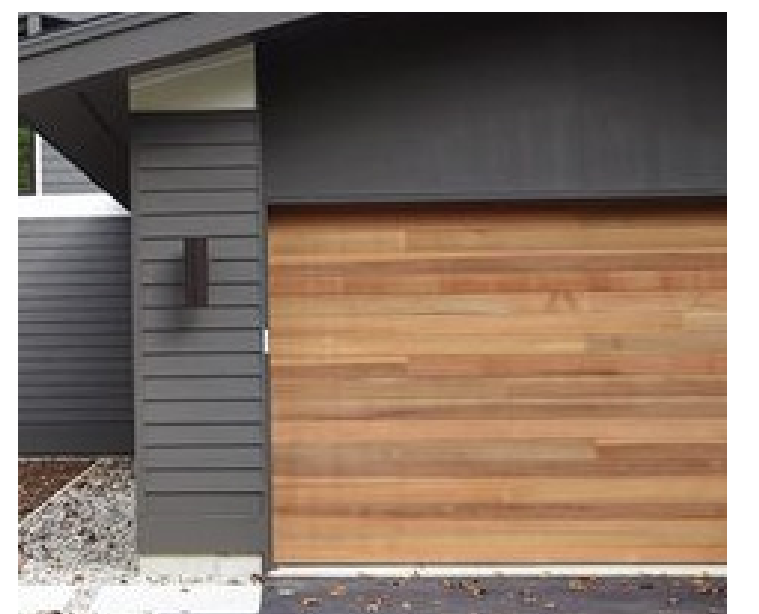

6. GARAGE DOORS: Natural wood Roll up doors - Western Red Cedar - Clr. polyurethane finish

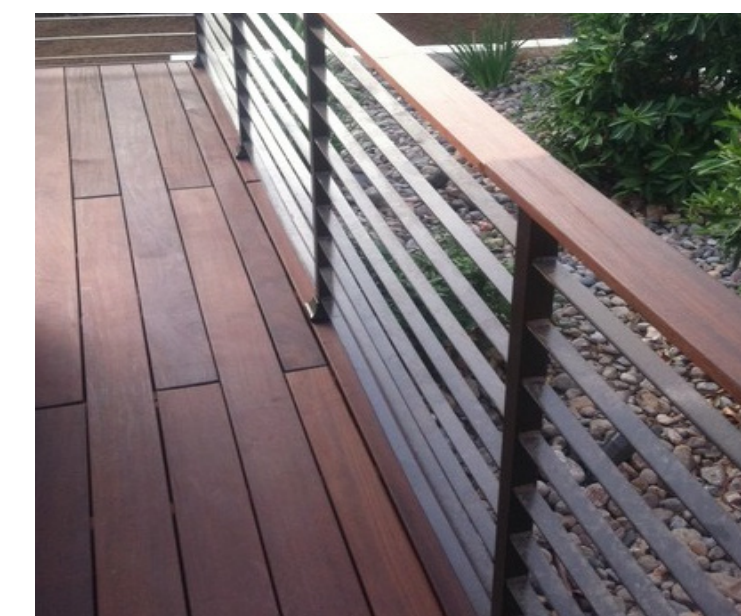

7. RAILINGS / BALCONY: Powder coated steel and natural wood top - bronze color to doors and windows and clr. polyurethane finish



8. OVERHANGS: Natural wood trellis- 4x12 douglas fir beams with clear polyurethane finish

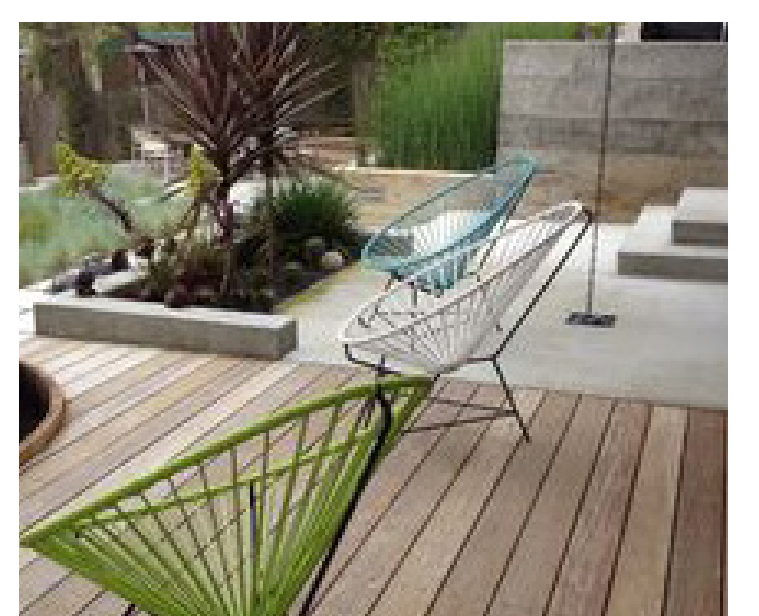

9. HARDSCAPE / DECKS: poured concrete and natural wood decks - 2x6 teak clr. polyurethane finish

ASSESSOR'S PARCEL NUMBER:
037-123-430

PROJECT ADDRESS:
199 ARBOR LANE, MOSS BEACH, SAN MATEO COUNTY, CA

PR-1.0

PROJECT RENDERINGS AND MATERIALS

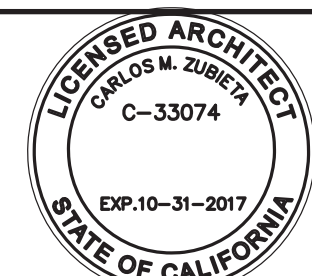

REVISIONS PER PLANNING SUBMITTAL COMMENTS 12-9-16

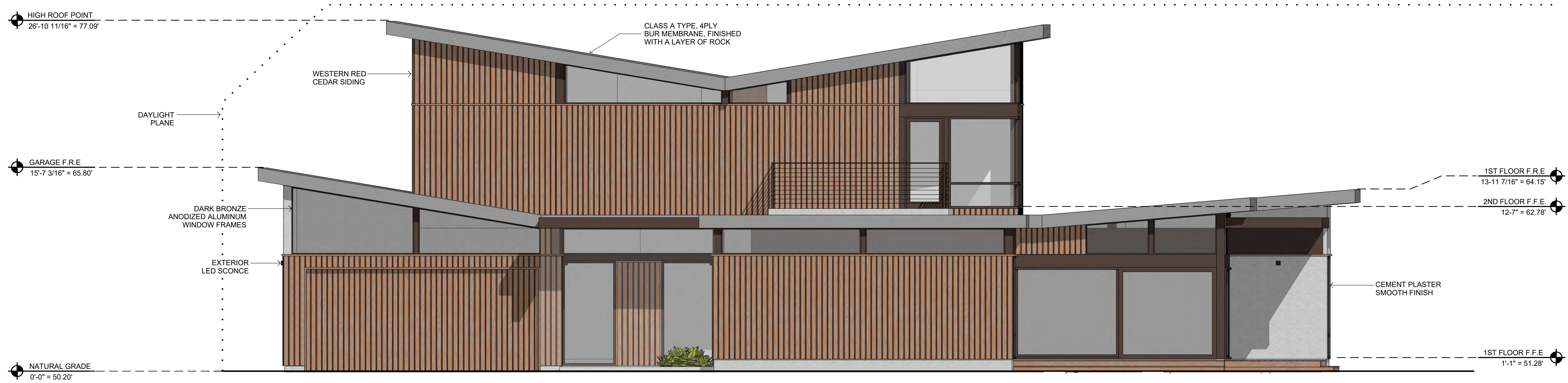

NORTH EXTERIOR ELEVATION 1
SCALE: 1/4" = 1'-0"

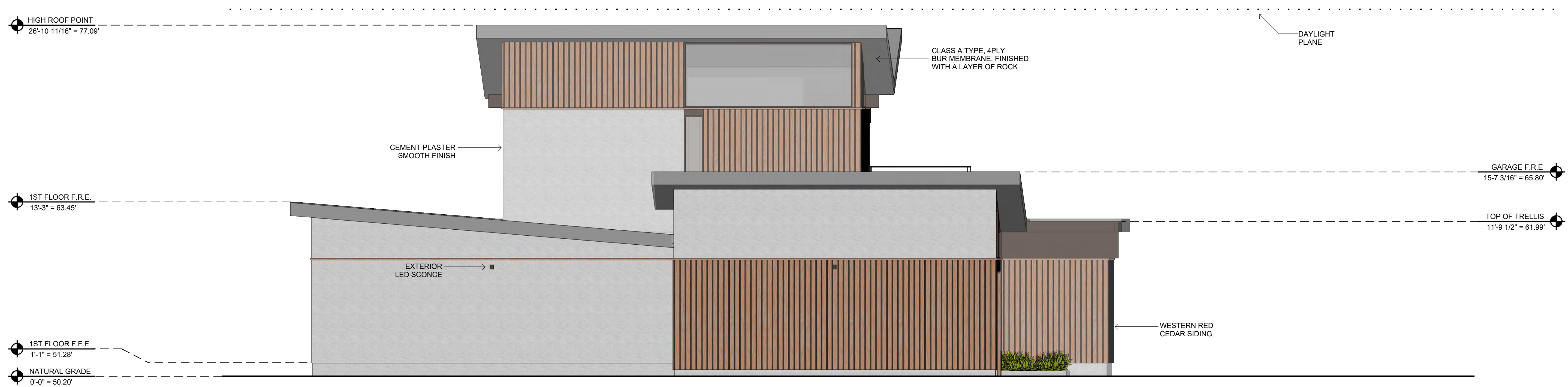

EAST EXTERIOR ELEVATION 2
SCALE: 1/4" = 1'-0"

SEE CORRESPONDING MATERIALS AND FINISHES
LEGEND ON PAGE PR-1.0



REVISIONS PER PLANNING SUBMITTAL COMMENTS 12-9-16

ASSESSOR'S PARCEL NUMBER:
037-123-430

PROJECT ADDRESS:
199 ARBOR LANE, MOSS BEACH, SAN MATEO COUNTY, CA

PR-1.1

EXTERIOR ELEVATIONS WITH MATERIALS

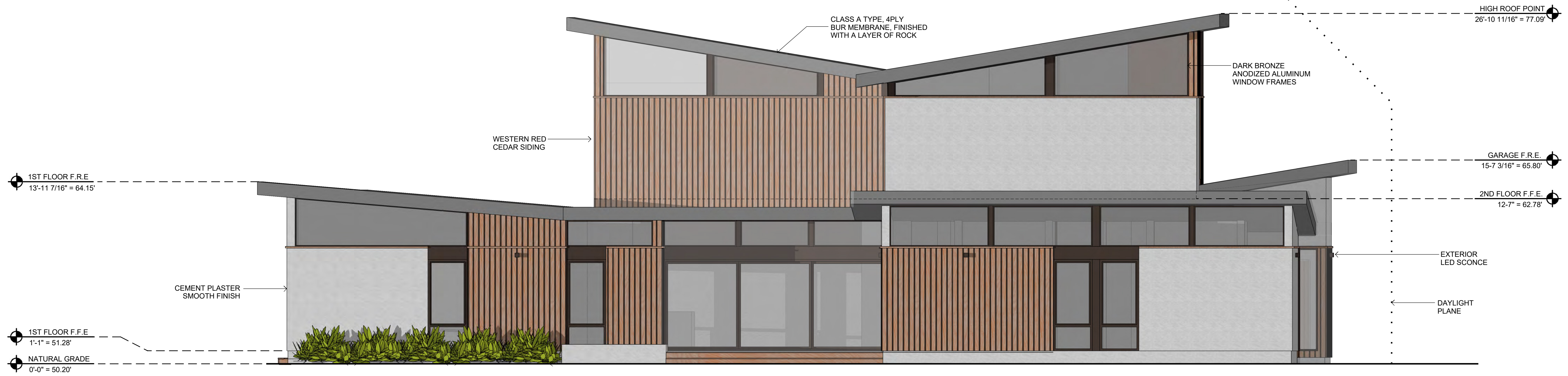

SOUTH EXTERIOR ELEVATION
SCALE: 1/4" = 1'-0" 1

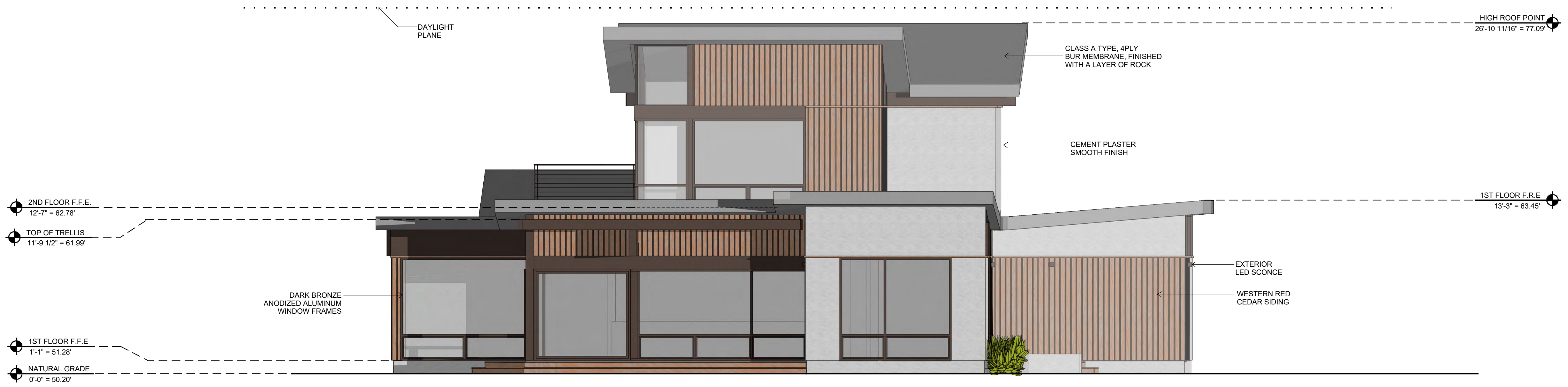

WEST EXTERIOR ELEVATION
SCALE: 1/4" = 1'-0" 2

SEE CORRESPONDING MATERIALS AND FINISHES
LEGEND ON PAGE PR-1.0

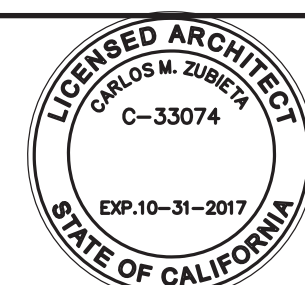

REVISIONS PER PLANNING SUBMITTAL COMMENTS 12-9-16

ASSESSOR'S PARCEL NUMBER:
037-123-430

PROJECT ADDRESS:
199 ARBOR LANE, MOSS BEACH, SAN MATEO COUNTY, CA

PR-1.2

EXTERIOR ELEVATIONS WITH MATERIALS

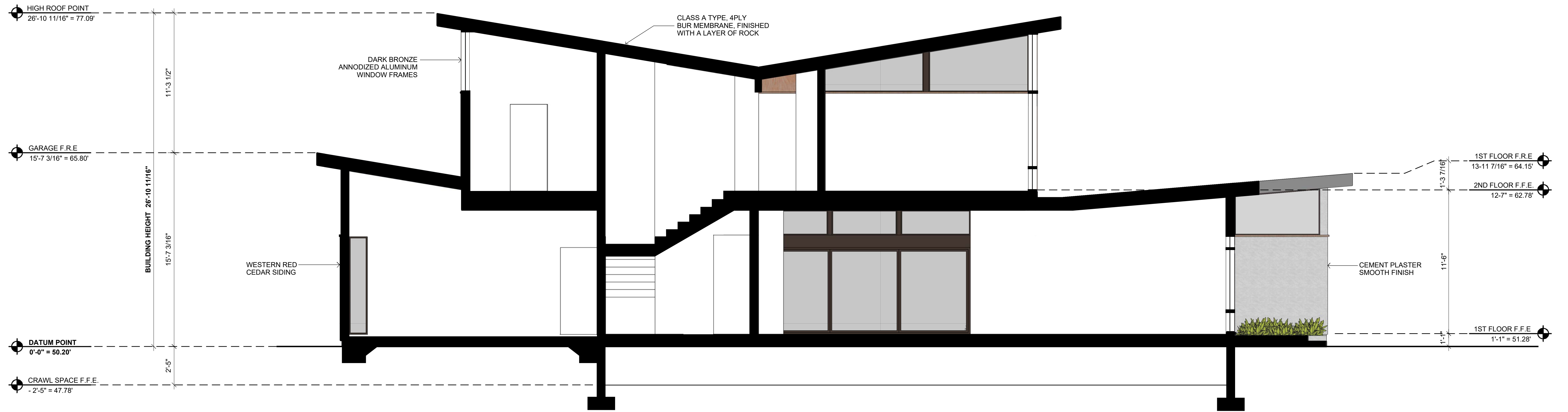

LONG BUILDING SECTION
SCALE: 1/4" = 1'-0" 1

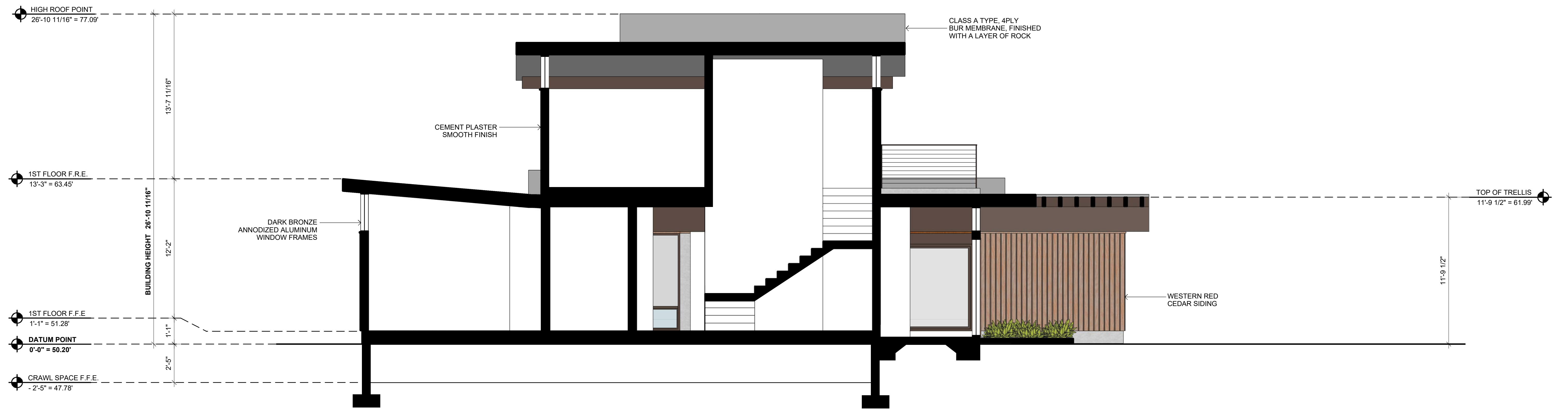

SHORT BUILDING SECTION
SCALE: 1/4" = 1'-0" 2

SEE CORRESPONDING MATERIALS AND FINISHES
LEGEND ON PAGE PR-1.0



199 ARBOR LANE - PROJECT SITE (VIEW TOWARDS ARBOR LANE)



191 ARBOR LANE - EXISTING HOUSE (EAST SIDE) ONLY IMMEDIATE NEIGHBOR



191 ARBOR LANE - EXISTING LOT - NORTH SIDE OF PROPERTY

NEIGHBORHOOD CONTEXT:

The homes on Arbor Lane, a cul-de-sac are one and two stories in height. The homes are a mix of similar style ranch homes built at the same time with newer second floor additions in a mix of colors and materials. All of the homes have the garages that face Arbor Lane. with varied roof lines that range from pitched to gabled. The proposed residence will be contemporary similar in materials and look and feel as some of the newer developments occurring in other neighborhoods in Moss Beach.



EXISTING ADJACENT HOUSE ON THE NORTH SIDE



181 ARBOR LANE - EXISTING ADJACENT HOUSE ON THE SOUTH SIDE



CONTEMPORARY PROJECT IN MOSS BEACH



CONTEMPORARY PROJECT IN MOSS BEACH

ASSESSOR'S PARCEL NUMBER:
037-123-430

PROJECT ADDRESS:
199 ARBOR LANE, MOSS BEACH, SAN MATEO COUNTY, CA

PR-1.4

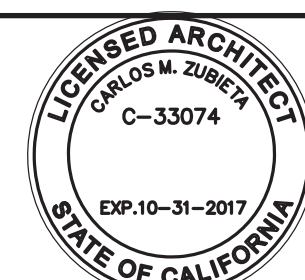

REVISIONS PER PLANNING SUBMITTAL COMMENTS 12-9-16

SURROUNDING NEIGHBORHOOD AND ROOF TYPES



LEA & BRAZZE ENGINEERING, INC.
 CIVIL ENGINEERS LAND SURVEYORS
 5455 INDUSTRIAL BLVD. SUITE 300
 HAYWARD, CALIFORNIA 94545
 (P) (510) 887-4086 (F) (510) 887-3019
 WWW.LEABRAZZE.COM

**199 ARBOR LANE
 MOSS BEACH
 CALIFORNIA**

**TOPOGRAPHIC
 SURVEY**

| REVISIONS | BY |
|-----------------|----|
| | |
| | |
| | |
| | |
| | |
| JOB NO: 2150245 | |
| DATE: 5-16-16 | |
| SCALE: 1" = 16' | |
| FIELD BY: DR | |
| DRAWN BY: DB | |
| SHEET NO: | |

SU1
 1 OF 1 SHEETS

NOTES

ALL DISTANCES AND DIMENSIONS ARE IN FEET AND DECIMALS OF A FOOT.
 UNDERGROUND UTILITY LOCATION IS BASED ON SURFACE EVIDENCE.
 BUILDING FOOTPRINTS ARE SHOWN AT GROUND LEVEL.
 FINISH FLOOR ELEVATIONS ARE TAKEN AT DOOR THRESHOLD (EXTERIOR)

EASEMENT NOTE

EASEMENTS SHOWN PER POLICY OF TITLE INSURANCE ISSUED BY FIRST AMERICAN TITLE COMPANY, POLICY NO. SM-327955, DATED APRIL 23, 1987. DUE TO DATE OF TITLE REPORT, EASEMENTS OF RECORD MAY EXIST THAT ARE NOT SHOWN ON THIS MAP.

BENCHMARK

MOSS BEACH/NGS BENCHMARK 1812
 1 MI S FROM MONTARA, 0.05 MILE NORTHWEST ALONG SEVENTH STREET FROM THE POST OFFICE AT MONTARA, THENCE 1.00 MILES SOUTHEAST ALONG STATE HIGHWAY 1, AT MOSS BEACH, AT THE JUNCTION OF STATE HIGHWAY 1 AND ETHELDORE STREET, 35 FEET NORTHEAST OF THE CENTER LINE OF THE HIGHWAY, 47 1/2 FEET SOUTHEAST OF THE CENTER LINE OF THE STREET, IN THE TOP AND 1.2 FEET NORTHWEST OF THE SOUTHEAST END OF THE NORTHEAST CONCRETE HEADWALL OF A 24 INCH PIPE CULVERT 35/29, AND ABOUT 1 FOOT LOWER THAN THE HIGHWAY.
 ELEVATION = 80.91
 (NAVD 88 DATUM)

SITE BENCHMARK

SURVEY CONTROL POINT
 MAG AND SHINER SET IN ASPHALT
 ELEVATION = 50.20'
 (NAVD 88)

LEGEND AND NOTES

- BOUNDARY LINE
- - - EASEMENT
- x- FENCE LINE
- - - FLOW LINE
- SANITARY SEWER LINE
- ⊕ BENCHMARK
- ▣ CB CATCH BASIN
- CO CLEAN-OUT BOX
- ⊗ FIRE HYDRANT
- FL FLOW LINE
- ⊠ GM GAS METER
- ⊠ GV GAS VALVE
- INV INVERT
- SSMH SANITARY SEWER MANHOLE
- SP STANDPIPE
- ★ STREET LIGHT
- TC TOP OF CURB
- VCP VITRIFIED CLAY PIPE
- ⊠ WV WATER VALVE
- XXX.XX SPOTGRADE
- ASPHALT
- CONCRETE
- SAND

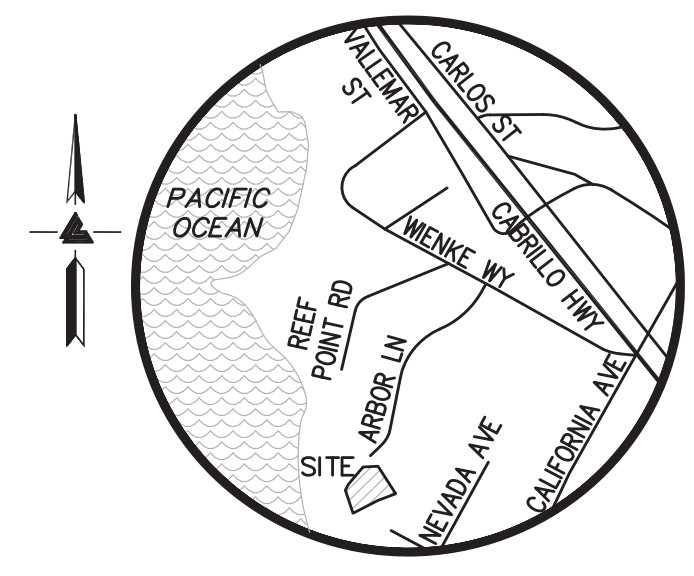

VICINITY MAP
 NO SCALE

PACIFIC OCEAN

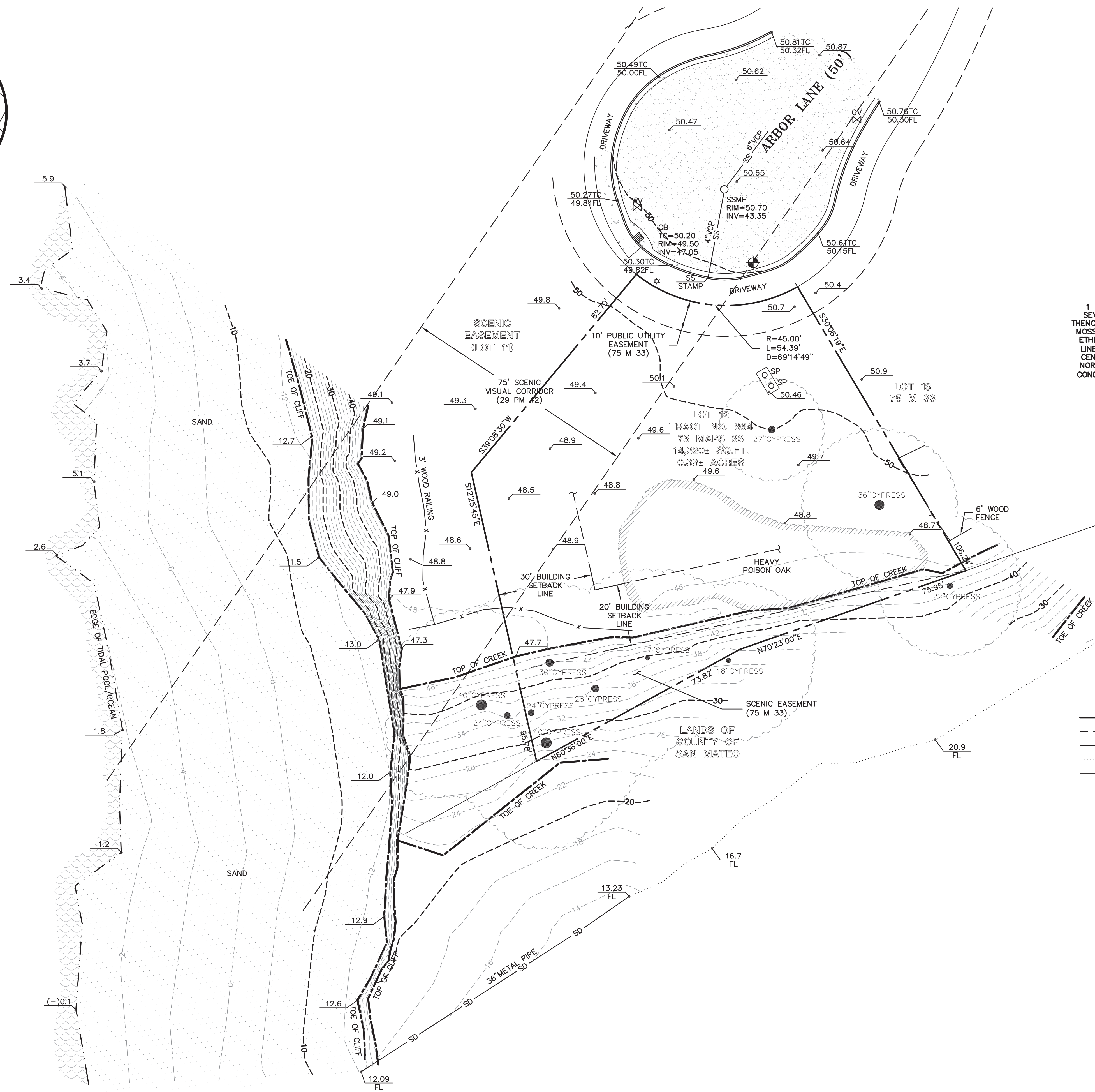
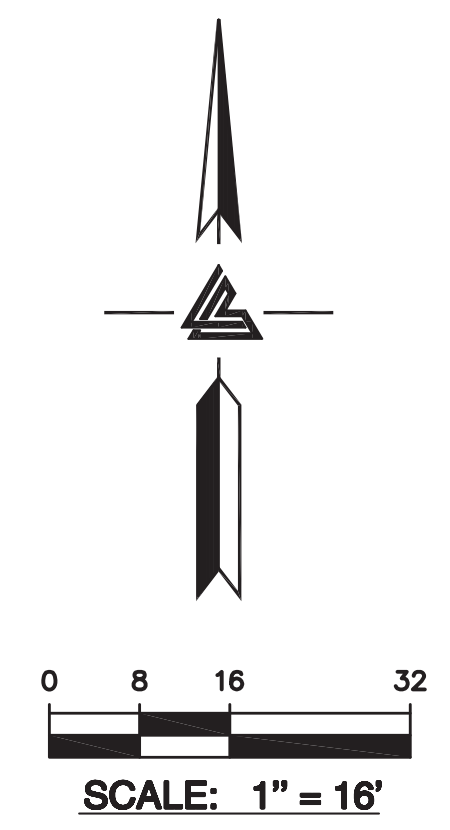

ASSESSOR'S PARCEL NUMBER:
 037-123-430

PROJECT ADDRESS:
 199 ARBOR LANE, MOSS BEACH, SAN MATEO COUNTY, CA



REVISIONS PER PLANNING SUBMITTAL COMMENTS 12-9-16

TOPOGRAPHIC SURVEY

SU-1.0

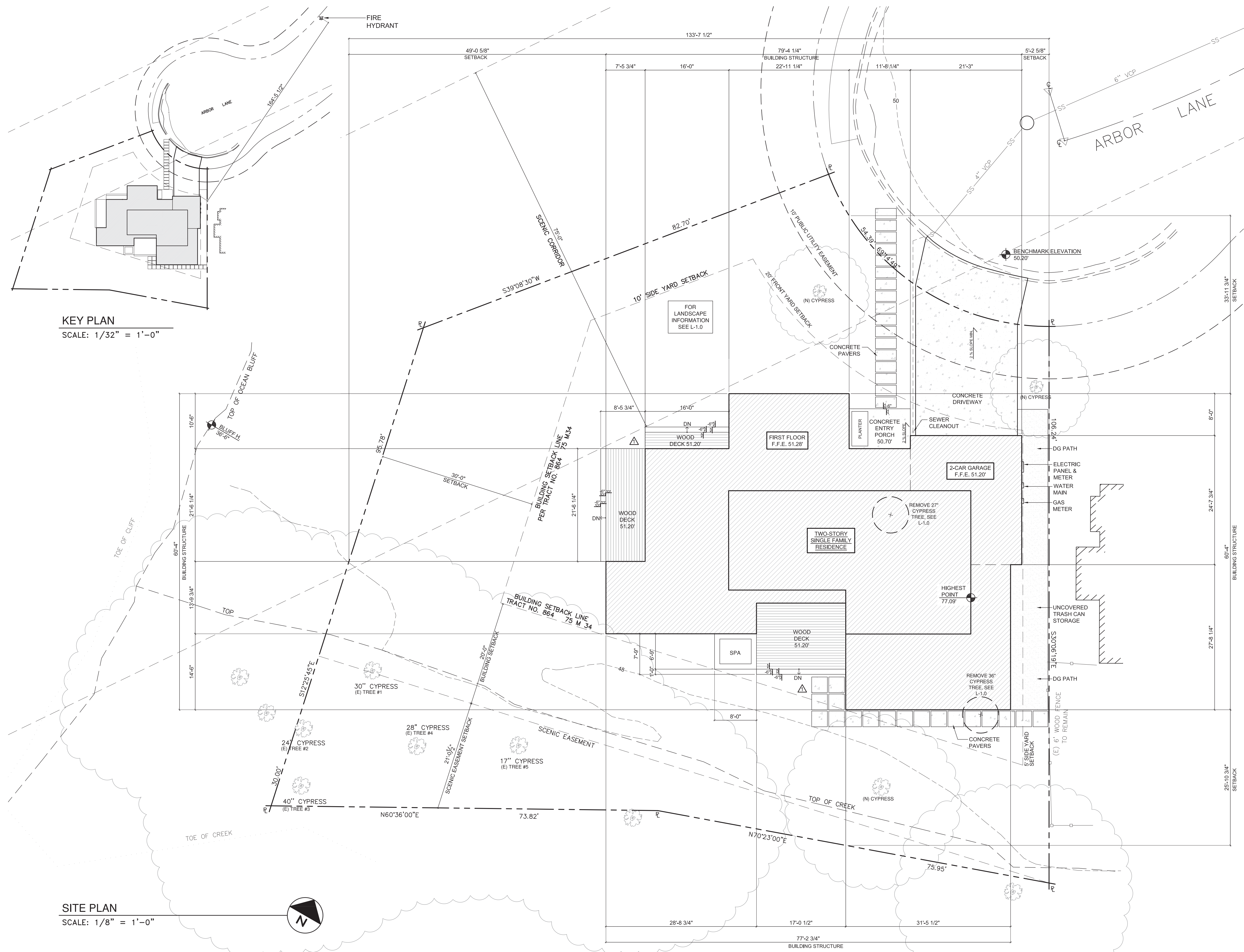

KEY PLAN
SCALE: 1/32" = 1'-0"

SITE PLAN
SCALE: 1/8" = 1'-0"

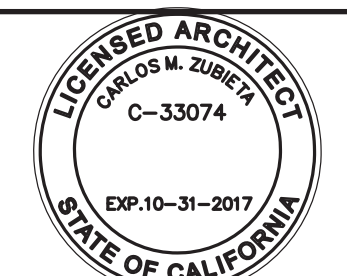
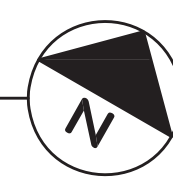

REVISIONS PER PLANNING SUBMITTAL COMMENTS 12-9-16

ASSESSOR'S PARCEL NUMBER:
037-123-430

PROJECT ADDRESS:
199 ARBOR LANE, MOSS BEACH, SAN MATEO COUNTY, CA

SITE PLAN

A1.0

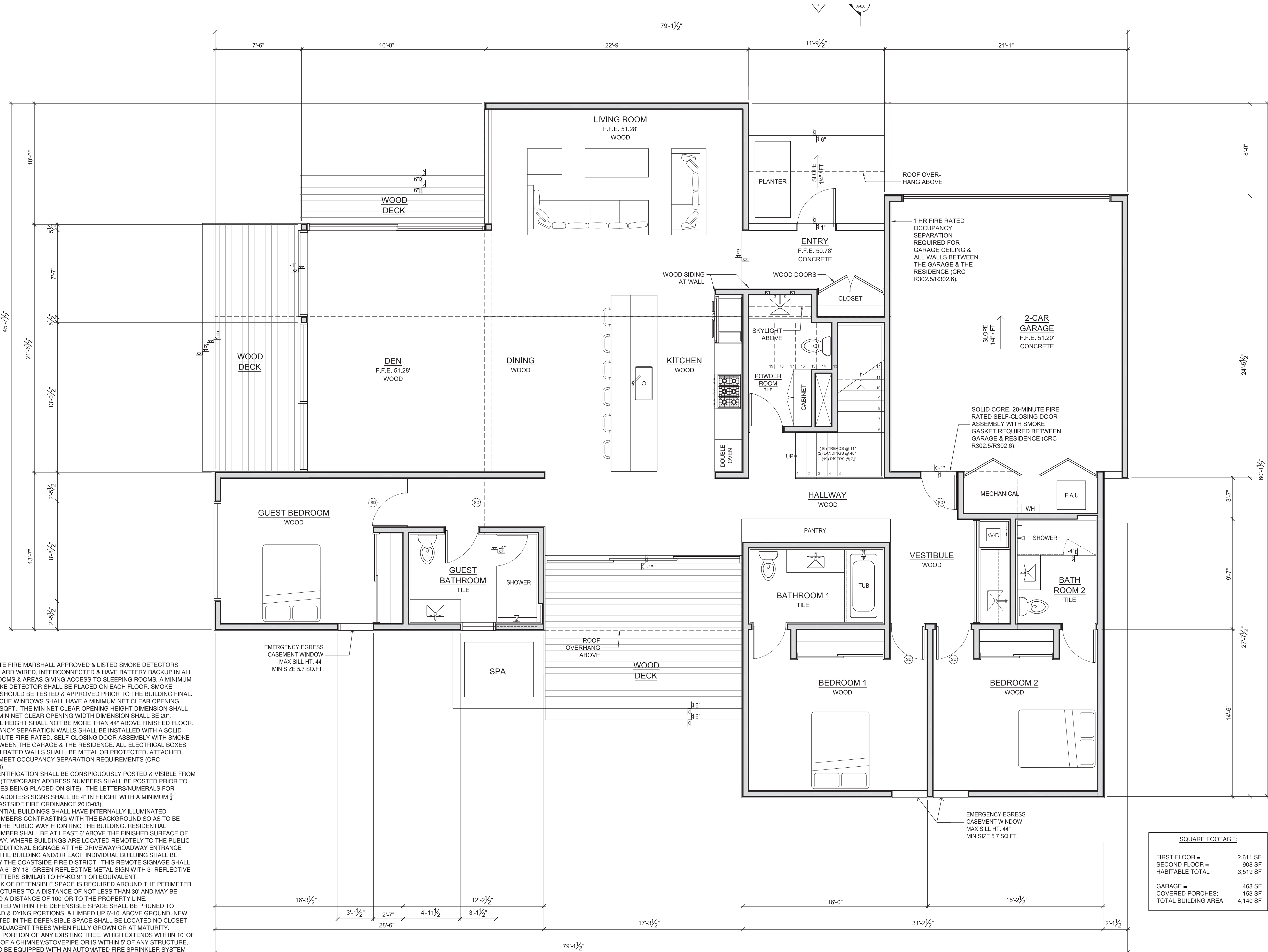

NOTES:

1. INSTALL STATE FIRE MARSHALL APPROVED & LISTED SMOKE DETECTORS WHICH ARE HARD WIRED, INTERCONNECTED & HAVE BATTERY BACKUP IN ALL SLEEPING ROOMS & AREAS GIVING ACCESS TO SLEEPING ROOMS. A MINIMUM OF ONE SMOKE DETECTOR SHALL BE PLACED ON EACH FLOOR. SMOKE DETECTORS SHOULD BE TESTED & APPROVED PRIOR TO THE BUILDING FINAL.
2. ESCAPE/RESCUE WINDOWS SHALL HAVE A MINIMUM NET CLEAR OPENING AREA OF 5.7 SQ.FT. THE MIN NET CLEAR OPENING HEIGHT DIMENSION SHALL BE 24". THE MIN NET CLEAR OPENING WIDTH DIMENSION SHALL BE 20". FINISHED SILL HEIGHT SHALL NOT BE MORE THAN 44" ABOVE FINISHED FLOOR.
3. 1-HR OCCUPANCY SEPARATION WALLS SHALL BE INSTALLED WITH A SOLID CORE, 20-MINUTE FIRE RATED, SELF-CLOSING DOOR ASSEMBLY WITH SMOKE GASKET BETWEEN THE GARAGE & THE RESIDENCE. ALL ELECTRICAL BOXES INSTALLED IN RATED WALLS SHALL BE METAL OR PROTECTED. ATTACHED GARAGE TO MEET OCCUPANCY SEPARATION REQUIREMENTS (CRC R302.5/R302.6).
4. BUILDING IDENTIFICATION SHALL BE CONSPICUOUSLY POSTED & VISIBLE FROM THE STREET (TEMPORARY ADDRESS NUMBERS SHALL BE POSTED PRIOR TO COMBUSTIBLES BEING PLACED ON SITE). THE LETTERS/NUMERALS FOR PERMANENT ADDRESS SIGNS SHALL BE 4" IN HEIGHT WITH A MINIMUM 2" STROKE (COASTSIDE FIRE ORDINANCE 2013-03).
5. NEW RESIDENTIAL BUILDINGS SHALL HAVE INTERNALLY ILLUMINATED ADDRESS NUMBERS CONTRASTING WITH THE BACKGROUND SO AS TO BE SEEN FROM THE PUBLIC WAY FRONTING THE BUILDING. RESIDENTIAL ADDRESS NUMBER SHALL BE AT LEAST 6' ABOVE THE FINISHED SURFACE OF THE DRIVEWAY, WHERE BUILDINGS ARE LOCATED REMOTELY TO THE PUBLIC ROADWAY. ADDITIONAL SIGNAGE AT THE DRIVEWAY/ROADWAY ENTRANCE LEADING TO THE BUILDING AND/OR EACH INDIVIDUAL BUILDING SHALL BE REQUIRED BY THE COASTSIDE FIRE DISTRICT. THIS REMOTE SIGNAGE SHALL CONSIST OF A 6" BY 18" GREEN REFLECTIVE METAL SIGN WITH 3" REFLECTIVE NUMBERS/LETTERS SIMILAR TO HY-KO 911 OR EQUIVALENT.
6. A FUEL BREAK OF DEFENSIBLE SPACE IS REQUIRED AROUND THE PERIMETER OF ALL STRUCTURES TO A DISTANCE OF NOT LESS THAN 30' AND MAY BE REQUIRED TO A DISTANCE OF 100' OR TO THE PROPERTY LINE.
7. TREES LOCATED WITHIN THE DEFENSIBLE SPACE SHALL BE PRUNED TO REMOVE DEAD & DYING PORTIONS, & LIMBED UP 6'-10' ABOVE GROUND. NEW TREES PLANTED IN THE DEFENSIBLE SPACE SHALL BE LOCATED NO CLOSER THAN 10' TO ADJACENT TREES WHEN FULLY GROWN OR AT MATURITY.
8. REMOVE THE PORTION OF ANY EXISTING TREE, WHICH EXTENDS WITHIN 10' OF THE OUTLET OF A CHIMNEY/STOVEPIPE OR IS WITHIN 5' OF ANY STRUCTURE.
9. DWELLING TO BE EQUIPPED WITH AN AUTOMATED FIRE SPRINKLER SYSTEM THROUGHOUT. ALL ATTIC LOCATIONS WILL BE PROVIDED WITH A PILOT HEAD ON A METAL UPRIGHT. ALL AREAS THAT ARE ACCESSIBLE FOR STORAGE PURPOSES SHALL BE EQUIPPED WITH FIRE SPRINKLERS INCLUDING CLOSETS & BATHROOMS, WITH THE EXCEPTION OF CLOSETS LESS THAN 24 SQFT WITH FULL DEPTH SHELVING (COASTSIDE FIRE DISTRICT ORDINANCE 2013-03).
10. INSTALLATION OF UNDERGROUND SPRINKLER PIPE SHALL BE FLUSHED & VISUALLY INSPECTED BY FIRE DISTRICT PRIOR TO HOOK-UP TO RISER.
11. EXTERIOR BELL & INTERIOR HORN/STROBES, ARE REQUIRED TO BE WIRED INTO THE REQUIRED FLOW SWITCH ON THE FIRE SPRINKLER SYSTEM. THE BELL, HORN/STROBE & FLOW SWITCH, ALONG WITH THE GARAGE DOOR OPENER ARE TO BE WIRED INTO A SEPARATE CIRCUIT BREAKER AT THE MAIN ELECTRICAL PANEL & LABELED.

| SQUARE FOOTAGE: | |
|-----------------------|----------|
| FIRST FLOOR = | 2,611 SF |
| SECOND FLOOR = | 908 SF |
| HABITABLE TOTAL = | 3,519 SF |
| | |
| GARAGE = | 468 SF |
| COVERED PORCHES: | 153 SF |
| TOTAL BUILDING AREA = | 4,140 SF |

FIRST FLOOR PLAN
SCALE: 1/4" = 1'-0"



REVISIONS PER PLANNING SUBMITTAL COMMENTS 12-9-16

ASSESSOR'S PARCEL NUMBER:
037-123-430

PROJECT ADDRESS:
199 ARBOR LANE, MOSS BEACH, SAN MATEO COUNTY, CA

A3.0

FIRST FLOOR PLAN

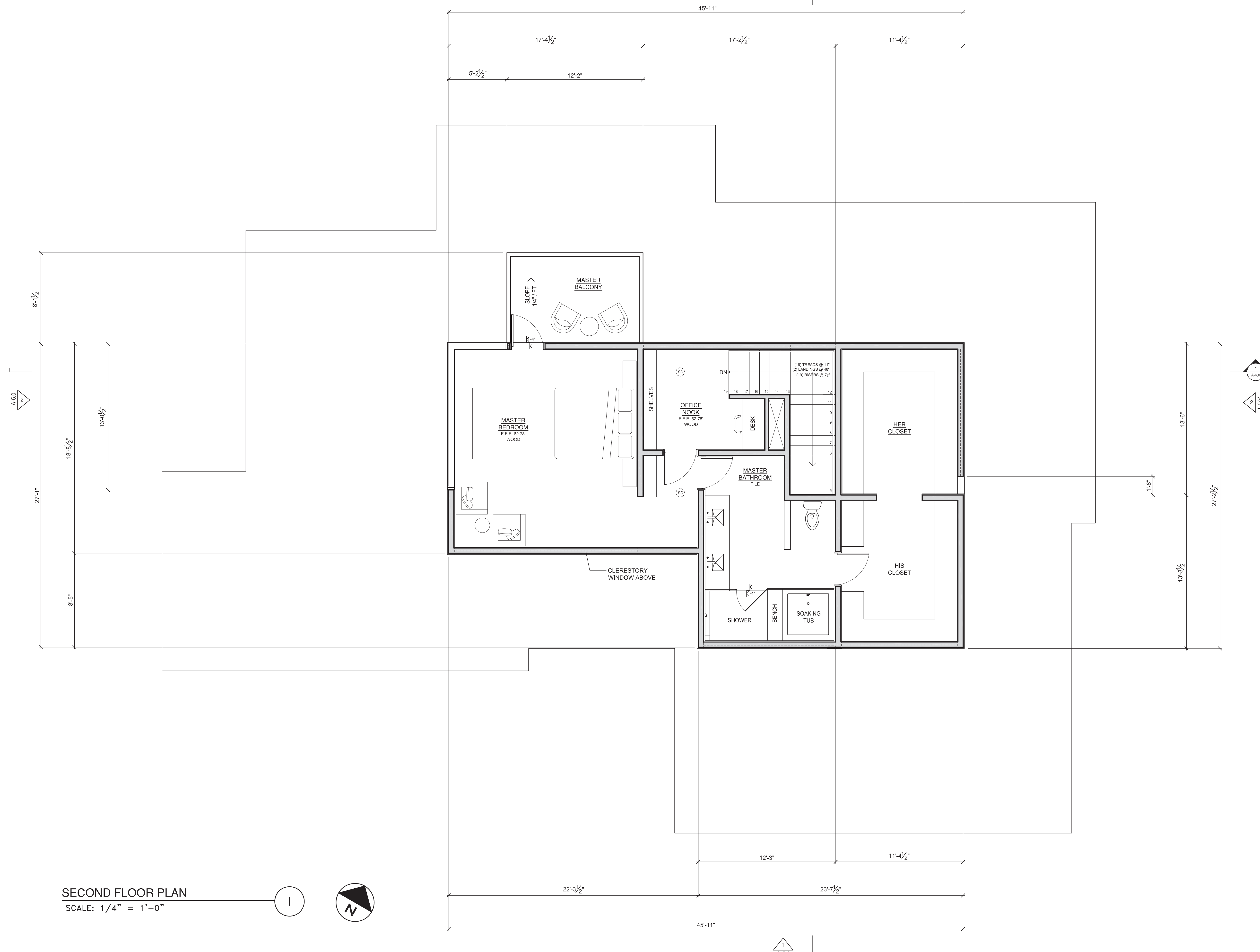

SECOND FLOOR PLAN
SCALE: 1/4" = 1'-0"



ASSESSOR'S PARCEL NUMBER:
037-123-430

PROJECT ADDRESS:
199 ARBOR LANE, MOSS BEACH, SAN MATEO COUNTY, CA

A3.1

REVISIONS PER PLANNING SUBMITTAL COMMENTS 12-9-16

SECOND FLOOR PLAN

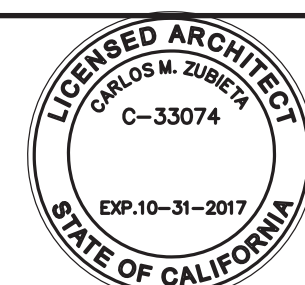

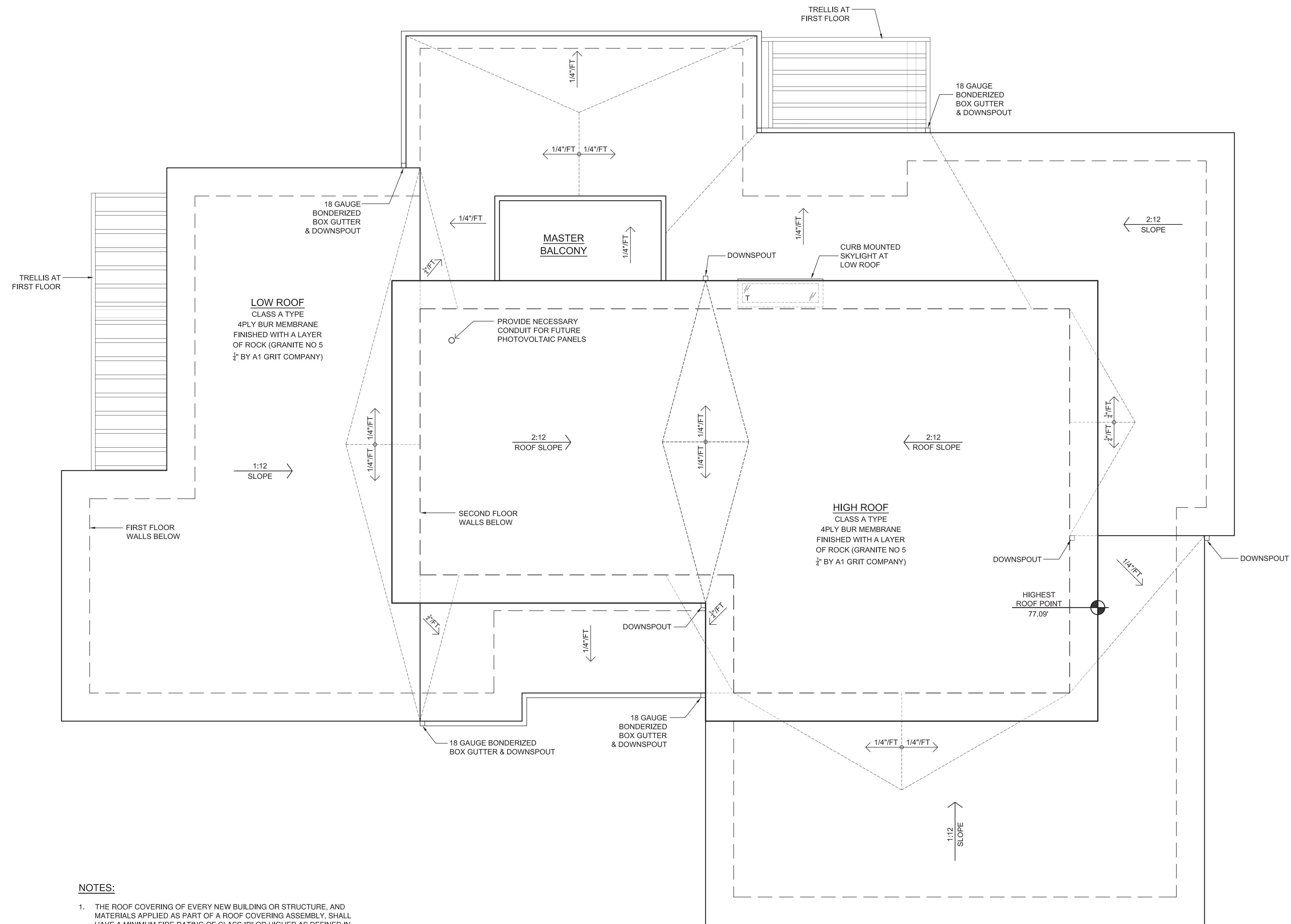

NOTES:

1. THE ROOF COVERING OF EVERY NEW BUILDING OR STRUCTURE, AND MATERIALS APPLIED AS PART OF A ROOF COVERING ASSEMBLY, SHALL HAVE A MINIMUM FIRE RATING OF CLASS "B" OR HIGHER AS DEFINED IN THE CURRENT EDITION OF THE CALIFORNIA BUILDING CODE.

ROOF PLAN

SCALE: 1/4" = 1'-0"

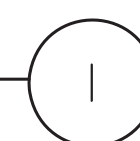

ASSESSOR'S PARCEL NUMBER:
037-123-430

PROJECT ADDRESS:
199 ARBOR LANE, MOSS BEACH, SAN MATEO COUNTY, CA

A3.2



REVISIONS PER PLANNING SUBMITTAL COMMENTS 12-9-16

ROOF PLAN

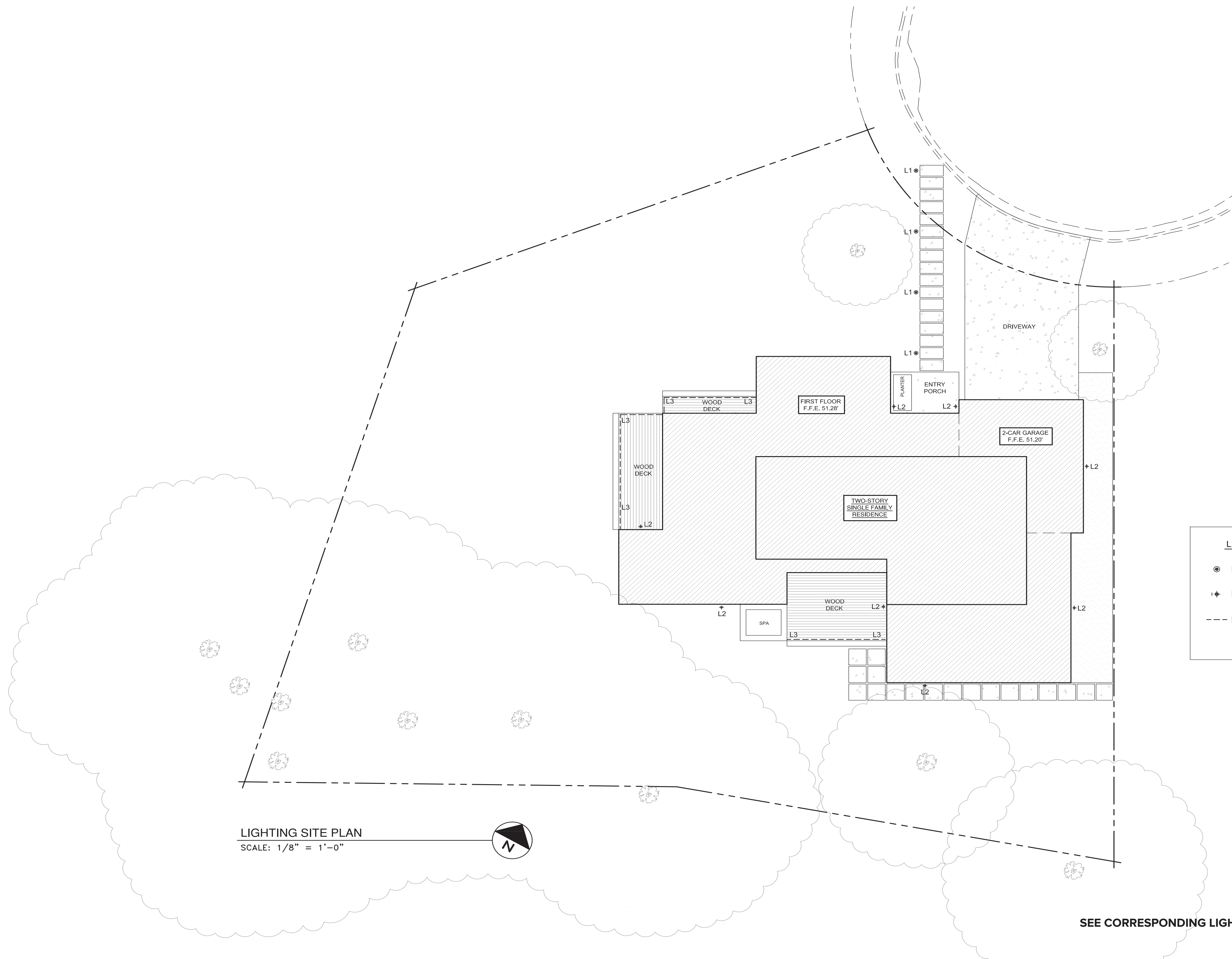

LIGHTING LEGEND

- ⊙ L1 = LED PATH LIGHT
HEVI LITE HL-6500
- ⊕ L2 = LED WALL SCONCE
LIGMAN UGI-31591
- L3 = LED DECK LIGHT
FLEX TUBE SC

LIGHTING SITE PLAN
SCALE: 1/8" = 1'-0"



SEE CORRESPONDING LIGHTING SPECS IN SPEC BOOK PAGE 25-27

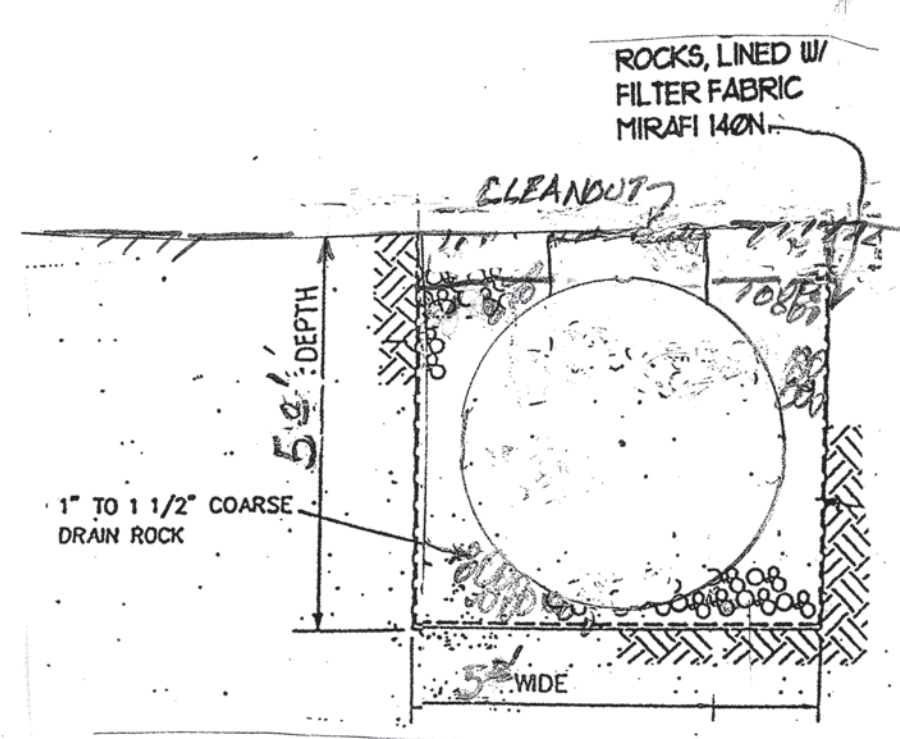
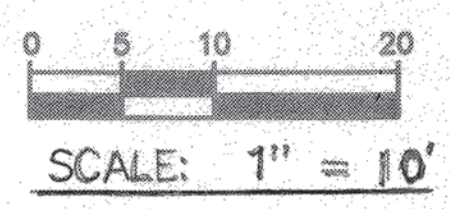
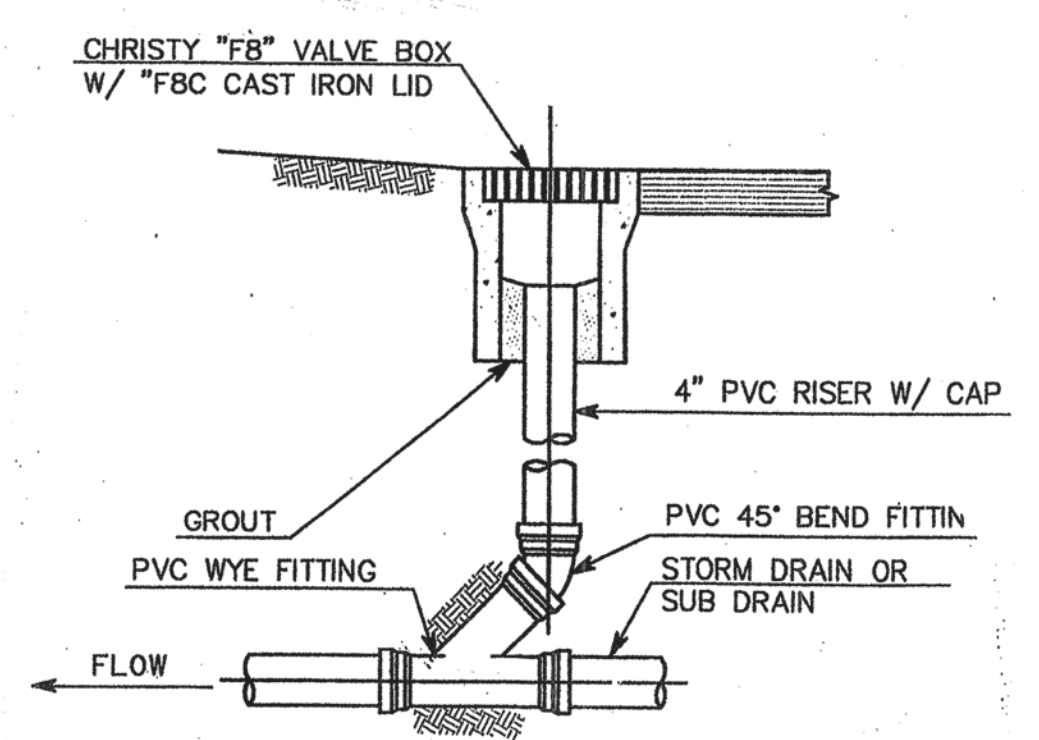
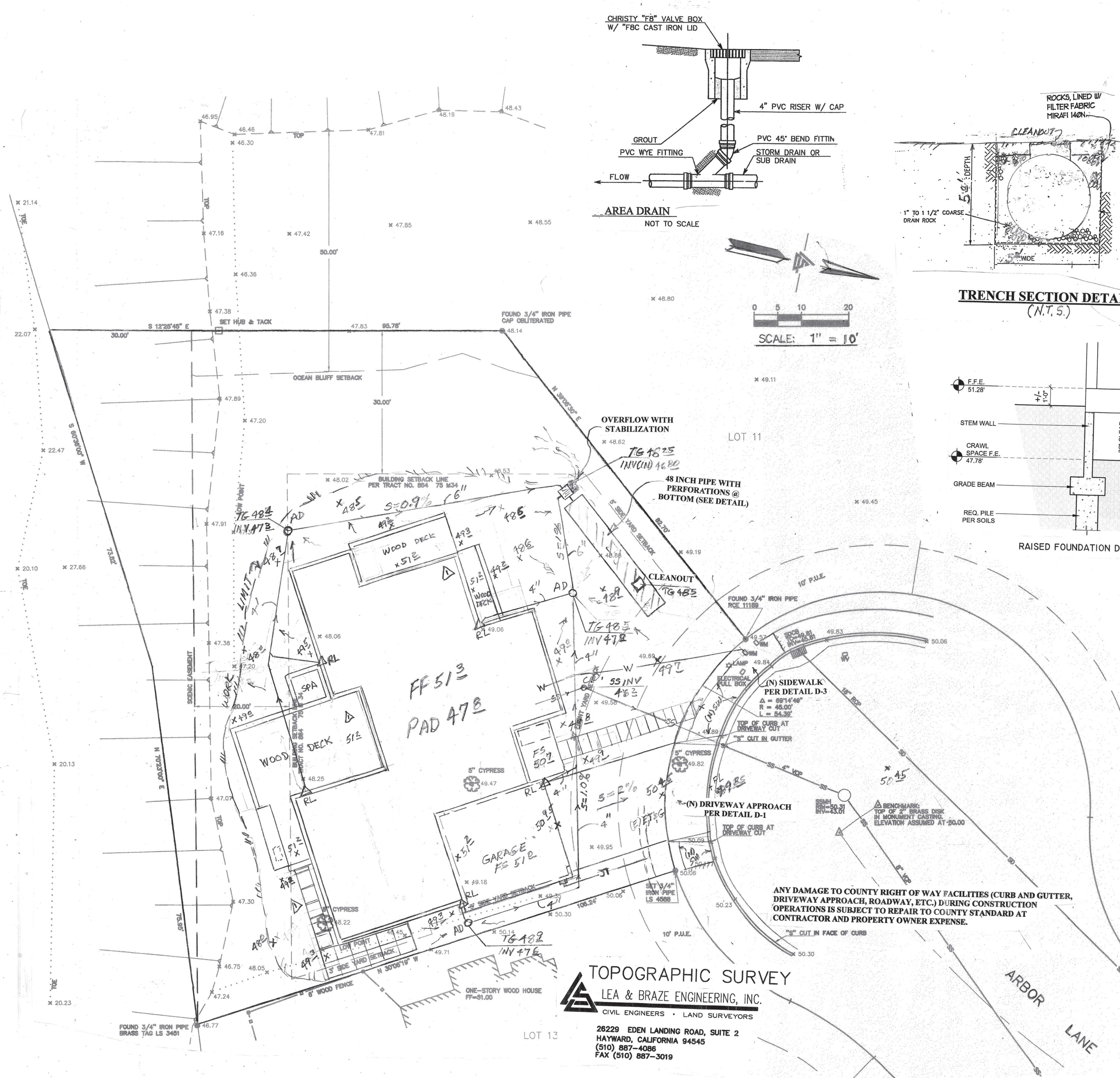

TRENCH SECTION DETAIL (N.T.S.)

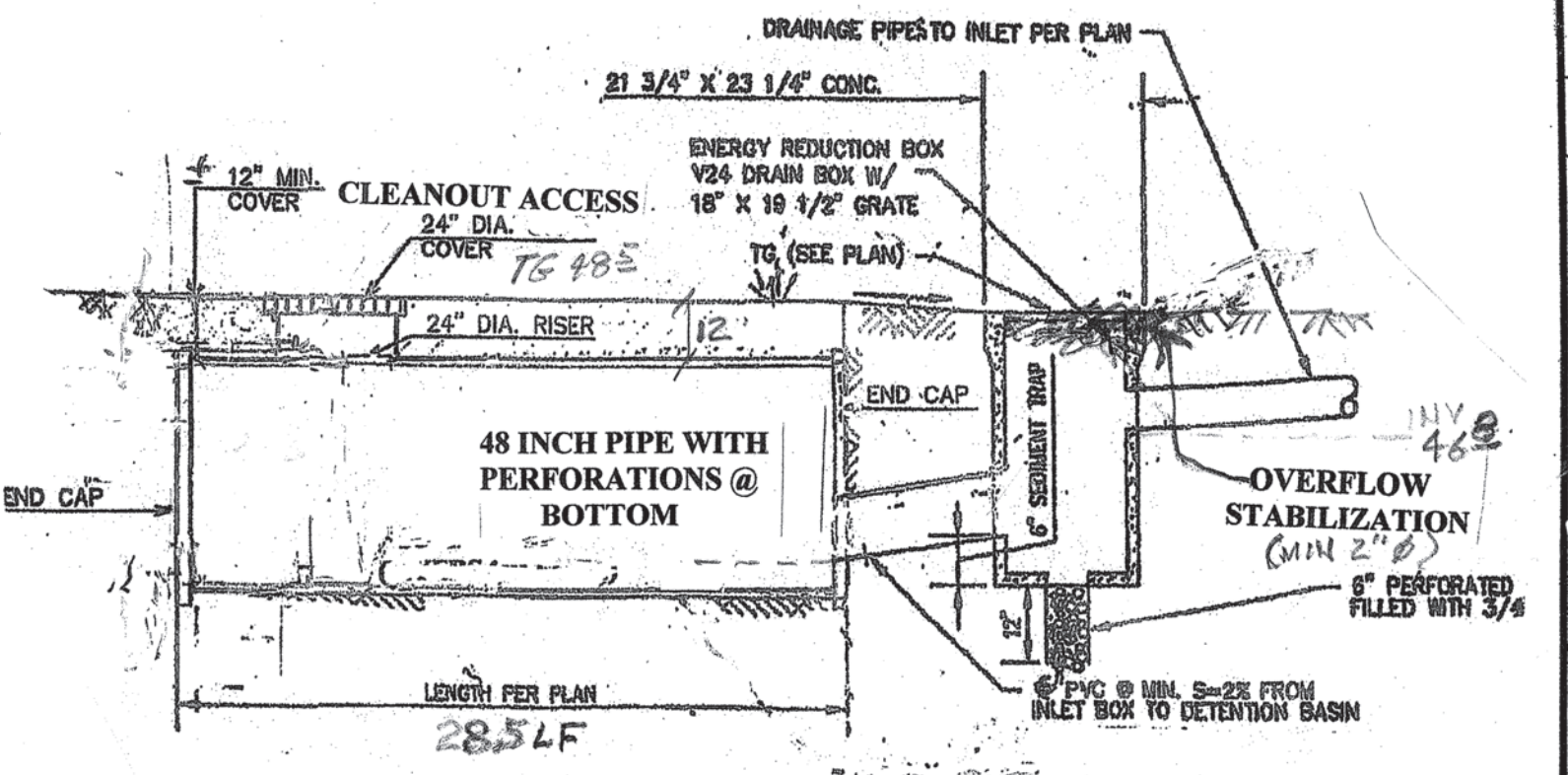

RETENTION PIPE DETAIL (NOT TO SCALE)

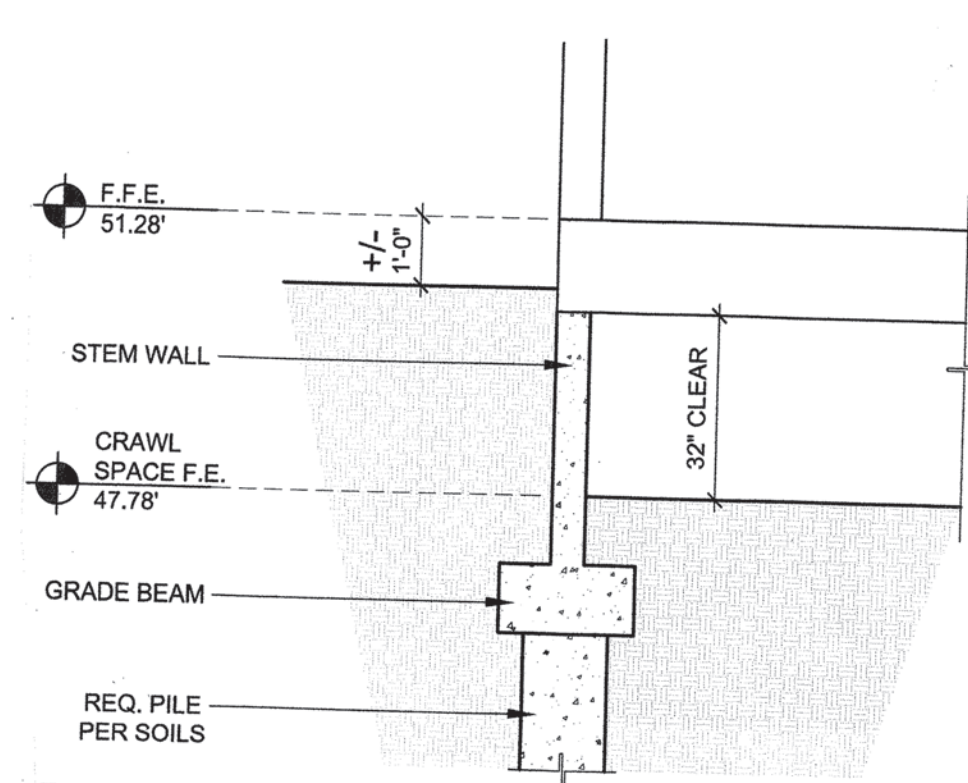

RAISED FOUNDATION DETAIL

GENERAL NOTES:

- RAIN WATER LEADERS SHALL BE CONNECTED TO STORM DRAIN SYSTEM, UNLESS OTHERWISE NOTED.
- ALL MATERIALS SHALL BE FURNISHED AND INSTALLED BY THE CONTRACTOR UNLESS OTHERWISE NOTED.
- WHEN APPLICABLE, ALL CONSTRUCTION MATERIALS AND METHODS SHALL COMPLY WITH THE ORDINANCES, SPECIFICATIONS AND STANDARDS OF THE COUNTY OF SAN MATEO, UNLESS OTHERWISE NOTED.
- CONTRACTOR SHALL NOTIFY UNDERGROUND SERVICE ALERT (U.S.A.) PRIOR TO START OF CONSTRUCTION. PHONE (800) 227-2600.
- UNLESS OTHERWISE SPECIFIED, ALL STORM DRAIN PIPES SHALL BE P.V.C. SDR 35 PER ASTM D3034 WITH BELL AND SPIGOT RUBBER GASKET JOINTS OR BETTER.
- THE CONTRACTOR SHALL BE RESPONSIBLE FOR DISTRIBUTING ANY EXCESS MATERIAL OR SUPPLYING MATERIAL FOR DEFICIENCIES TO BRING DRIVEWAY AND BUILDING PADS TO REQUIRED GRADE.
- UTILITIES AND UNDERGROUND FACILITIES INDICATED ARE FOR INFORMATION ONLY. IT IS THE CONTRACTOR'S RESPONSIBILITY TO VERIFY THE LOCATION AND DEPTH WITH THE APPROPRIATE AGENCIES. NEITHER THE OWNER NOR THE CITY OR THE ENGINEER ASSUMES RESPONSIBILITY THAT THE UTILITIES AND UNDERGROUND FACILITIES INDICATED WILL BE THE UTILITIES AND UNDERGROUND FACILITIES ENCOUNTERED.
- THE CONTRACTOR IS RESPONSIBLE FOR MATCHING EXISTING SURROUNDING LANDSCAPE AND OTHER IMPROVEMENTS WITH A SMOOTH TRANSITION IN PAVING, GRADING, ETC., AND TO AVOID ABRUPT OR APPARENT CHANGES OR CROSS SLOPES, LOW SPOTS OR HAZARDOUS CONDITIONS.
- STORM DRAIN ... LINE INSTALLATIONS SHALL BEGIN FROM THE DOWNSTREAM POINT OF CONNECTION. NOTIFY THE ENGINEER IF THERE IS A DISCREPANCY IN INVERT ELEVATIONS BETWEEN ACTUAL AND AS SHOWN ON PLAN.
- THE APPLICANT / CONTRACTOR SHALL OBTAIN AN ENCROACHMENT PERMIT FROM THE COUNTY'S ENGINEERING DIVISION PRIOR TO COMMENCING ANY WORK IN COUNTY'S RIGHT-OF-WAY.
- THE CONTRACTOR SHALL OBTAIN ALL NECESSARY PERMITS FOR ALL WORK SHOWN ON THIS PLAN.

EARTHWORK SUMMARY:

| | |
|------------|--------|
| EXCAVATION | 186 CY |
| EMBANKMENT | 182 CY |
| (BALANCE) | |

LEGEND

| | |
|-----|---------------------------|
| RL | ROOF LEADER |
| → | DIRECTION OF SURFACE FLOW |
| AD | AREA DRAIN |
| TG | TOP OF GRATE ELEVATION |
| INV | PIPE INVERT ELEVATION |
| (E) | EXISTING |
| FS | FINISH SURFACE ELEVATION |

TOPOGRAPHIC SURVEY
LEA & BRAZE ENGINEERING, INC.
CIVIL ENGINEERS • LAND SURVEYORS
26229 EDEN LANDING ROAD, SUITE 2
HAYWARD, CALIFORNIA 94545
(510) 887-4086
FAX (510) 887-3019

REGISTERED PROFESSIONAL ENGINEER
JOHN C. BERRY
No. 18720
JOHN C. BERRY
RCE 18720
EXP. 6-30-17

BERRY & ASSOCIATES
1733 WOODSIDE ROAD, SUITE 335
REDWOOD CITY, CA 94061
PHONE: 650/368-0750 FAX: 650/368-1810

PRLIMINARY

SITE GRADING, DRAINAGE & UTILITY PLAN
199 ARBOR LANE
MOSS BEACH, CA

DATE: _____
BY: _____
DESCRIPTION: _____
REV: _____

DRAWN BY: JCB
DESIGNED BY:
CHECKED BY:
SCALE: 1"=10'
DATE: 10/12/16
DRAWING NO: 13070
SHEET C-1
1 OF 1

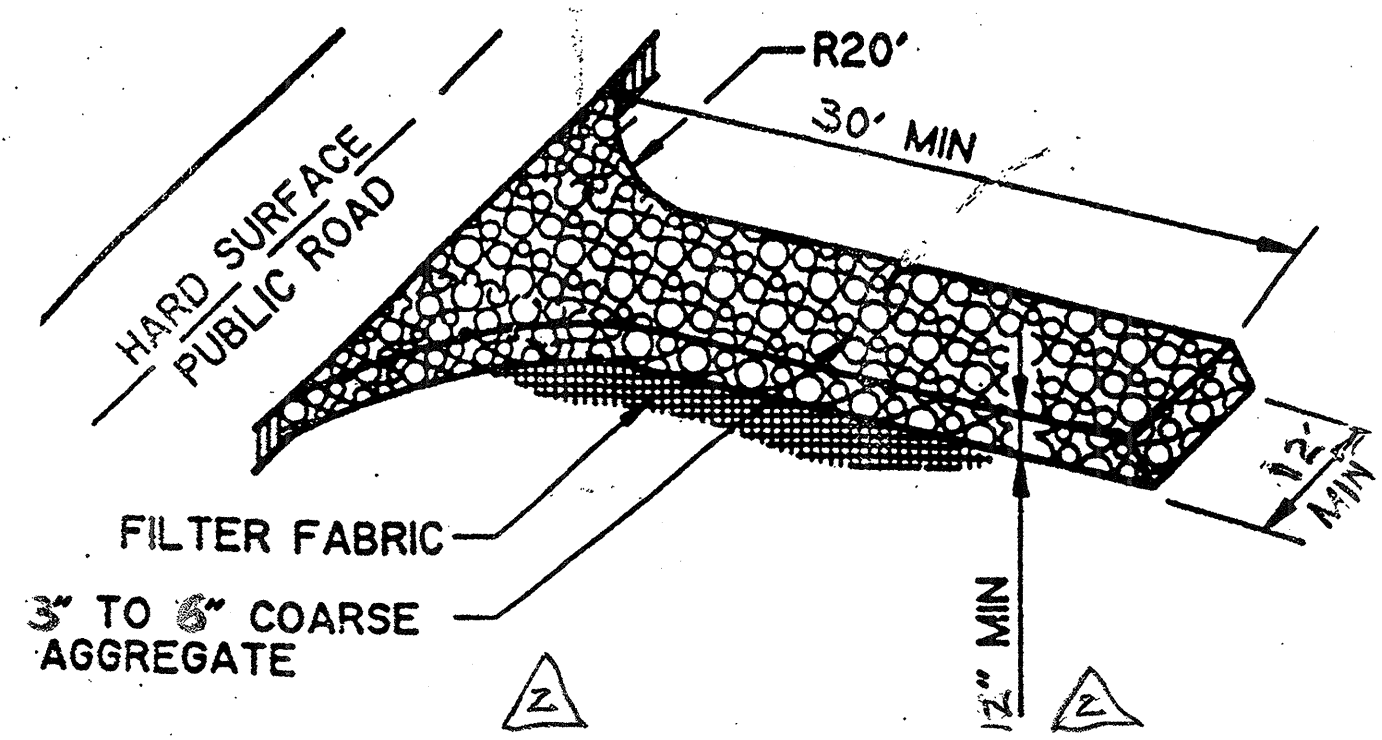

STABILIZED CONSTRUCTION ENTRANCE

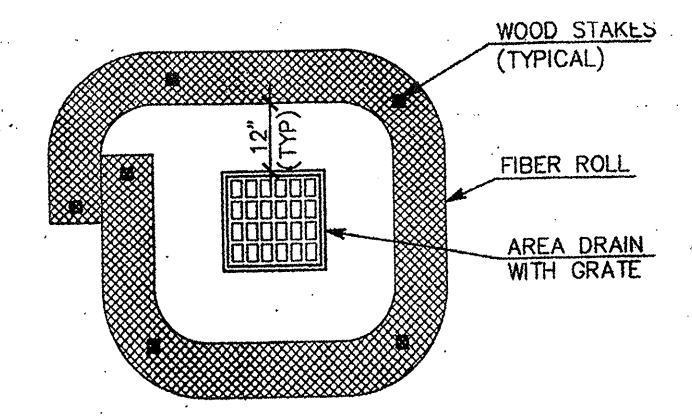

DRAIN INLET PROTECTION DETAIL
(NOT TO SCALE)

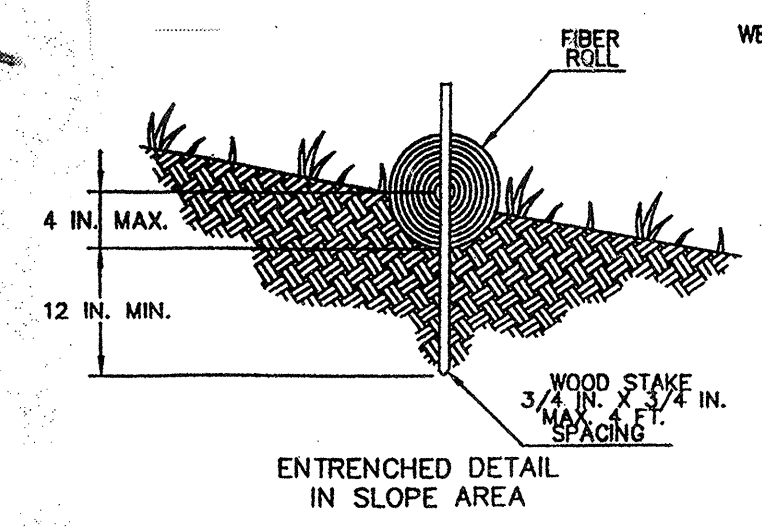

ENTRENCHED DETAIL IN SLOPE AREA

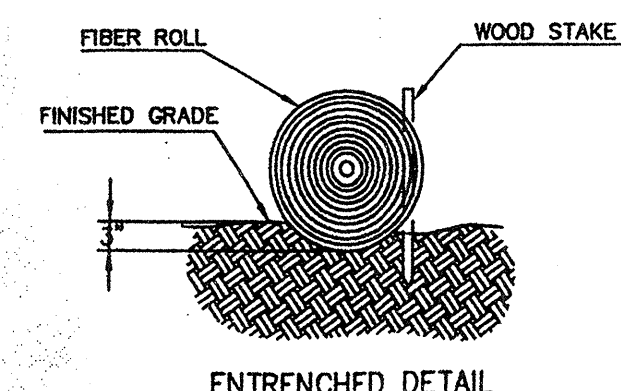

ENTRENCHED DETAIL IN FLAT AREA

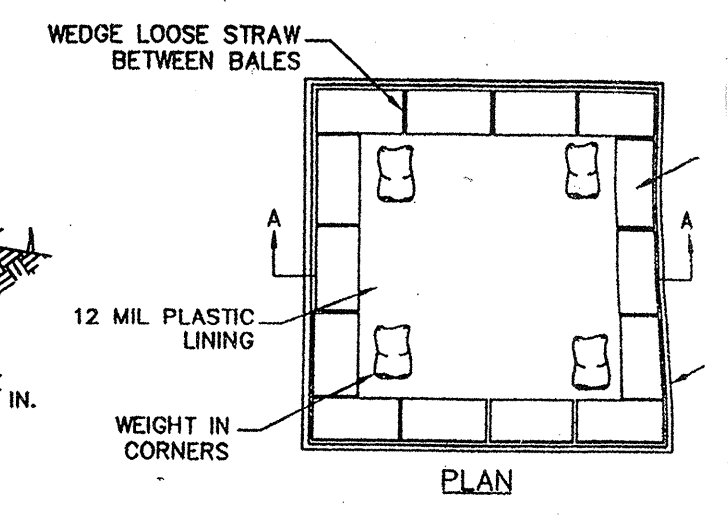

TEMPORARY CONCRETE WASHOUT FACILITY

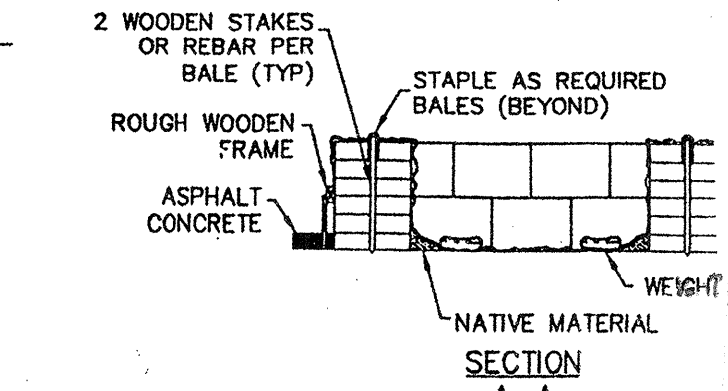

STRAW WADDLE ROLLS
BIOWATTLE

EROSION CONTROL POINT OF CONTACT

JOHN C. BERRY
BERRY AND ASSOCIATES
1733 WOODSIDE ROAD #335
REDWOOD CITY, CA 94061
PHONE: (650) 400-9003

BEST MANAGEMENT PRACTICES (BMP's)
THE CONTRACTOR SHALL ADHERE TO
BEST MANAGEMENT PRACTICES (BMP's)
FOR STORM WATER POLLUTION PREVENTION
IN ALL CONSTRUCTION OPERATIONS.

Prior to issuance of the grading permit "hard card," the property owner shall submit a schedule of all grading operations to the Current Planning Section, subject to review and approval by the Current Planning Section. Along with the "hard card" application, the applicant shall submit a letter to the Current Planning Section, at least two (2) weeks prior to commencement of grading, stating the date when grading operations will begin, anticipated end date of grading operations, including dates of revegetation, and estimated date of establishment of newly planted vegetation. If the schedule of grading operations calls for the grading to be completed in one grading season, then the winterizing plan shall be considered a contingent plan to be implemented if work falls behind schedule.

GENERAL EROSION CONTROL NOTES:

1. THE INTENT OF THE EROSION CONTROL PLAN IS TO MINIMIZE ANY WATER QUALITY IMPACTS IN THE FORM OF SEDIMENT POLLUTION TO MAIN CREEK & TRIBUTARIES.
2. A CONSTRUCTION ENTRANCE WILL BE INSTALLED PRIOR TO OF GRADING. LOCATION OF THE ENTRANCE MAY BE ADJUSTED BY THE CONTRACTOR TO FACILITATE GRADING OPERATIONS. ALL CONSTRUCTION TRAFFIC ENTERING THE PAVED ROAD MUST CROSS THE CONSTRUCTION ENTRANCE. THE ENTRANCE SHALL BE MAINTAINED IN A CONDITION THAT WILL PREVENT TRACKING OR FLOWING OF SEDIMENT ONTO PUBLIC RIGHTS-OF-WAY. THIS MAY REQUIRE PERIODIC TOP DRESSING WITH ADDITIONAL STONE AS CONDITION DEMAND, AND REPAIR OF ANY MEASURES USED TO SEDIMENTS.
3. WHEN NECESSARY, WHEELS SHALL BE CLEANED TO REMOVE SEDIMENT PRIOR TO ENTRANCE ONTO PUBLIC RIGHT-OF-WAY. WHEN WASHING IS REQUIRED, IT SHALL BE DONE ON AN AREA STABILIZED WITH CRUSHED STONE WHICH DRAINS INTO AN APPROVED SEDIMENT BASIN. ALL SEDIMENT SHALL BE PREVENTED FROM ENTERING ANY STORM DRAIN, DITCH, OR WATERCOURSE THROUGH THE USE OF SAND BAGS, GRAVEL, BOARDS OR OTHER APPROVED METHODS.
4. THE EROSION AND SEDIMENT CONTROL MEASURES WILL BE OPERABLE ALL YEAR LONG, UNTIL GRADING AND INSTALLATION OF STORM DRAINAGE AND PERMANENT EROSION AND SEDIMENT CONTROL FACILITIES WILL BE COMPLETED. NO GRADING WILL OCCUR BETWEEN OCTOBER 1 AND APRIL 15 UNLESS AUTHORIZED BY THE CITY REPRESENTATIVE.
5. DURING THE RAINY SEASON, ALL PAVED AREAS WILL BE KEPT CLEAR OF EARTH MATERIAL AND DEBRIS. THE SITE WILL BE MAINTAINED SO THAT A MINIMUM OF SEDIMENT-LADEN RUNOFF ENTERS THE STORM DRAINAGE SYSTEM.
6. ALL EROSION AND SEDIMENTATION CONTROL MEASURES SHALL BE IN ACCORDANCE WITH THE EROSION AND SEDIMENT CONTROL FIELD MANUAL OF THE CALIFORNIA REGIONAL WATER QUALITY CONTROL BOARD, 4TH EDITION, DATED AUGUST 2002.
7. AREAS DESIGNATED FOR PARKING OF CONSTRUCTION VEHICLES SHALL USE AGGREGATE OVER GEO-TEXTILE FABRIC.
8. LOCATE PORTABLE TOILETS AWAY FROM SURFACE WATER LOCATIONS AND STORM DRAIN INLETS.
9. PERFORM CLEARING AND EARTH-MOVING ACTIVITIES ONLY DURING DRY WEATHER. MEASURES TO ENSURE ADEQUATE EROSION AND SEDIMENT CONTROL SHALL BE INSTALLED PRIOR TO EARTH-MOVING ACTIVITIES AND CONSTRUCTION.
10. MEASURES TO ENSURE ADEQUATE EROSION AND SEDIMENT CONTROL ARE REQUIRED YEAR-ROUND. STABILIZE ALL DENUDEED AREAS AND MAINTAIN EROSION CONTROL MEASURES CONTINUOUSLY BETWEEN OCTOBER 1 AND APRIL 30.
11. STORE, HANDLE, AND DISPOSE OF CONSTRUCTION MATERIALS AND WASTES PROPERLY, SO AS TO PREVENT THEIR CONTACT WITH STORMWATER.
12. CONTROL AND PREVENT THE DISCHARGE OF ALL POTENTIAL POLLUTANTS, INCLUDING PAVEMENT CUTTING WASTES, PAINTS, CONCRETE, PETROLEUM PRODUCTS, CHEMICALS, WASH WATER OR SEDIMENTS, AND NON-STORMWATER DISCHARGES TO STORM DRAINS AND WATERCOURSES.
13. USE SEDIMENT CONTROLS OR FILTRATION TO REMOVE SEDIMENT WHEN DEWATERING SITE AND OBTAIN REGIONAL WATER QUALITY CONTROL BOARD (RWQCB) PERMIT(S) AS NECESSARY.
14. AVOID CLEANING, FUELING, OR MAINTAINING VEHICLES ON-SITE, EXCEPT IN A DESIGNATED AREA WHERE WASH WATER IS CONTAINED AND TREATED.
15. LIMIT AND TIME APPLICATIONS OF PESTICIDES AND FERTILIZERS TO PREVENT POLLUTED RUNOFF.
16. LIMIT CONSTRUCTION ACCESS ROUTES TO STABILIZED, DESIGNATED ACCESS POINTS.
17. AVOID TRACKING DIRT OR OTHER MATERIALS OFF-SITE. CLEAN OFF-SITE PAVED AREAS AND SIDEWALKS USING DRY SWEEPING METHODS.
18. TRAIN AND PROVIDE INSTRUCTION TO ALL EMPLOYEES AND SUBCONTRACTORS REGARDING THE WATERSHED PROTECTION MAINTENANCE STANDARDS AND CONSTRUCTION BEST MANAGEMENT PRACTICES.
19. PLACEMENT OF EROSION MATERIALS AT THESE LOCATIONS IS REQUIRED ON WEEKENDS AND DURING RAIN EVENTS AS SHOWN ON PLAN.
20. THE AREAS DELINEATED ON THE PLANS FOR PARKING, GRUBBING, STORAGE ETC., SHALL NOT BE ENLARGED OR "RUN OVER."
21. CONSTRUCTION SITES ARE REQUIRED TO HAVE EROSION CONTROL MATERIALS ON-SITE DURING THE "OFF-SEASON."
22. DUST CONTROL IS REQUIRED YEAR-ROUND.
23. EROSION CONTROL MATERIALS SHALL BE STORED ON-SITE.
24. USE OF PLASTIC SHEETING BETWEEN OCTOBER 1ST AND APRIL 30TH IS NOT ACCEPTABLE UNLESS FOR USE ON STOCKPILE WHERE THE STOCKPILE IS ALSO PROTECTED WITH FIBER ROLLS CONTAINING THE BASE OF THE STOCKPILE.
25. THE TREE PROTECTION SHALL BE IN PLACE BEFORE ANY GRADING, EXCAVATING OR GRUBBING IS STARTED.
26. CONSTRUCTION DURATION IS ANTICIPATED TO BE APPROXIMATELY 12 MONTHS. (BEGINNING APRIL 30, 2019)

KEY

- BIOWATTLES
- STABILIZED CONSTRUCTION ENTRANCE
- INLET PROTECTION

JOHN C. BERRY
RCE 18720
EXP. 6-30-17

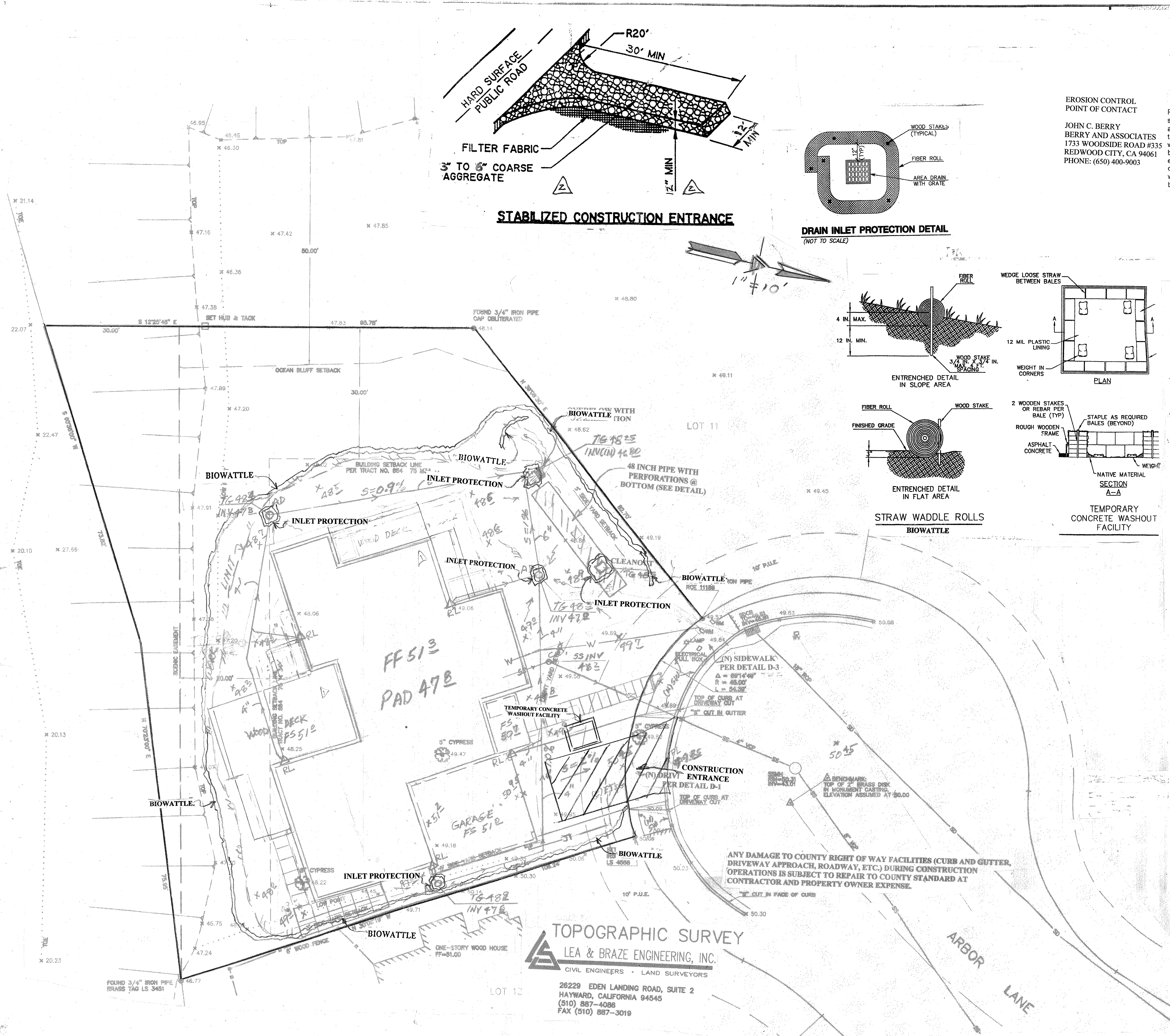

TOPOGRAPHIC SURVEY
LEA & BRAZE ENGINEERING, INC.
CIVIL ENGINEERS • LAND SURVEYORS
28229 EDEN LANDING ROAD, SUITE 2
HAYWARD, CALIFORNIA 94545
(510) 887-4088
FAX (510) 887-3019

BERRY & ASSOCIATES
1733 WOODSIDE ROAD, SUITE 335
REDWOOD CITY, CA 94061
PHONE: 650/368-0750 FAX: 650/368-1810

EROSION CONTROL PLAN
199 ARBOR LANE
MOSS BEACH, CA

DRAWN BY: *JCB*
DESIGNED BY:
CHECKED BY:
SCALE: 1" = 10'
DATE: 12/12/16
DRAWING NO. 3010
SHEET C-2

Construction Best Management Practices (BMPs)

Construction projects are required to implement the stormwater best management practices (BMP) on this page, as they apply to your project, all year long.

Materials & Waste Management

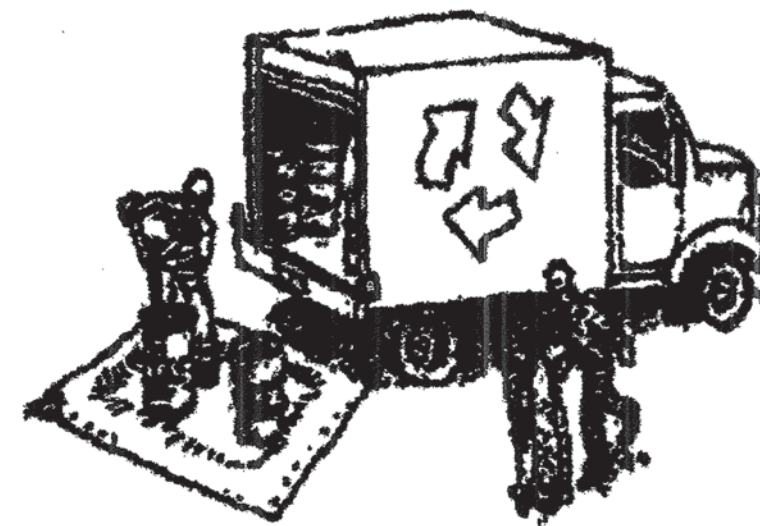

Non-Hazardous Materials

- Berm and cover stockpiles of sand, dirt or other construction material with tarps when rain is forecast or if not actively being used within 14 days.
- Use (but don't overuse) reclaimed water for dust control.

Hazardous Materials

- Label all hazardous materials and hazardous wastes (such as pesticides, paints, thinners, solvents, fuel, oil, and antifreeze) in accordance with city, county, state and federal regulations.
- Store hazardous materials and wastes in water tight containers, store in appropriate secondary containment, and cover them at the end of every work day or during wet weather or when rain is forecast.
- Follow manufacturer's application instructions for hazardous materials and be careful not to use more than necessary. Do not apply chemicals outdoors when rain is forecast within 24 hours.
- Arrange for appropriate disposal of all hazardous wastes.

Waste Management

- Cover waste disposal containers securely with tarps at the end of every work day and during wet weather.
- Check waste disposal containers frequently for leaks and to make sure they are not overfilled. Never hose down a dumpster on the construction site.
- Clean or replace portable toilets, and inspect them frequently for leaks and spills.
- Dispose of all wastes and debris properly. Recycle materials and wastes that can be recycled (such as asphalt, concrete, aggregate base materials, wood, gyp board, pipe, etc.)
- Dispose of liquid residues from paints, thinners, solvents, glues, and cleaning fluids as hazardous waste.

Construction Entrances and Perimeter

- Establish and maintain effective perimeter controls and stabilize all construction entrances and exits to sufficiently control erosion and sediment discharges from site and tracking off site.
- Sweep or vacuum any street tracking immediately and secure sediment source to prevent further tracking. Never hose down streets to clean up tracking.

Equipment Management & Spill Control



Maintenance and Parking

- Designate an area, fitted with appropriate BMPs, for vehicle and equipment parking and storage.
- Perform major maintenance, repair jobs, and vehicle and equipment washing off site.
- If refueling or vehicle maintenance must be done onsite, work in a bermed area away from storm drains and over a drip pan or drop cloths big enough to collect fluids. Recycle or dispose of fluids as hazardous waste.
- If vehicle or equipment cleaning must be done onsite, clean with water only in a bermed area that will not allow rinse water to run into gutters, streets, storm drains, or surface waters.
- Do not clean vehicle or equipment onsite using soaps, solvents, degreasers, or steam cleaning equipment.

Spill Prevention and Control

- Keep spill cleanup materials (e.g., rags, absorbents and cat litter) available at the construction site at all times.
- Inspect vehicles and equipment frequently for and repair leaks promptly. Use drip pans to catch leaks until repairs are made.
- Clean up spills or leaks immediately and dispose of cleanup materials properly.
- Do not hose down surfaces where fluids have spilled. Use dry cleanup methods (absorbent materials, cat litter, and/or rags).
- Sweep up spilled dry materials immediately. Do not try to wash them away with water, or bury them.
- Clean up spills on dirt areas by digging up and properly disposing of contaminated soil.
- Report significant spills immediately. You are required by law to report all significant releases of hazardous materials, including oil. To report a spill: 1) Dial 911 or your local emergency response number, 2) Call the Governor's Office of Emergency Services Warning Center, (800) 852-7550 (24 hours).

Earthmoving



- Schedule grading and excavation work during dry weather.
- Stabilize all denuded areas, install and maintain temporary erosion controls (such as erosion control fabric or bonded fiber matrix) until vegetation is established.
- Remove existing vegetation only when absolutely necessary, and seed or plant vegetation for erosion control on slopes or where construction is not immediately planned.
- Prevent sediment from migrating offsite and protect storm drain inlets, gutters, ditches, and drainage courses by installing and maintaining appropriate BMPs, such as fiber rolls, silt fences, sediment basins, gravel bags, berms, etc.
- Keep excavated soil on site and transfer it to dump trucks on site, not in the streets.

Contaminated Soils

- If any of the following conditions are observed, test for contamination and contact the Regional Water Quality Control Board:
 - Unusual soil conditions, discoloration, or odor.
 - Abandoned underground tanks.
 - Abandoned wells
 - Buried barrels, debris, or trash.

Paving/Asphalt Work



- Avoid paving and seal coating in wet weather or when rain is forecast, to prevent materials that have not cured from contacting stormwater runoff.
- Cover storm drain inlets and manholes when applying seal coat, tack coat, slurry seal, fog seal, etc.
- Collect and recycle or appropriately dispose of excess abrasive gravel or sand. Do NOT sweep or wash it into gutters.
- Do not use water to wash down fresh asphalt concrete pavement.

Sawcutting & Asphalt/Concrete Removal

- Protect nearby storm drain inlets when saw cutting. Use filter fabric, catch basin inlet filters, or gravel bags to keep slurry out of the storm drain system.
- Shovel, absorb, or vacuum saw-cut slurry and dispose of all waste as soon as you are finished in one location or at the end of each work day (whichever is sooner!)
- If sawcut slurry enters a catch basin, clean it up immediately.

Concrete, Grout & Mortar Application

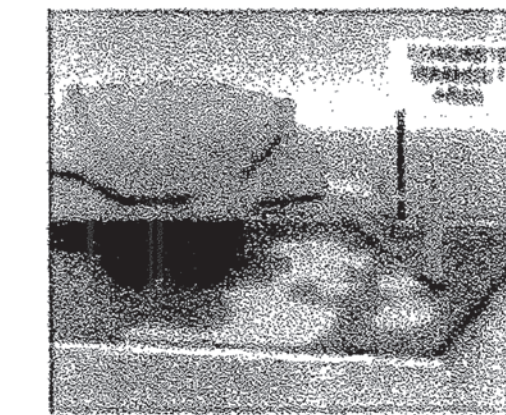

- Store concrete, grout, and mortar away from storm drains or waterways, and on pallets under cover to protect them from rain, runoff, and wind.
- Wash out concrete equipment/trucks offsite or in a designated washout area, where the water will flow into a temporary waste pit, and in a manner that will prevent leaching into the underlying soil or onto surrounding areas. Let concrete harden and dispose of as garbage.
- When washing exposed aggregate, prevent washwater from entering storm drains. Block any inlets and vacuum gutters, hose washwater onto dirt areas, or drain onto a bermed surface to be pumped and disposed of properly.

Landscaping



- Protect stockpiled landscaping materials from wind and rain by storing them under tarps all year-round.
- Stack bagged material on pallets and under cover.
- Discontinue application of any erodible landscape material within 2 days before a forecast rain event or during wet weather.

Painting & Paint Removal

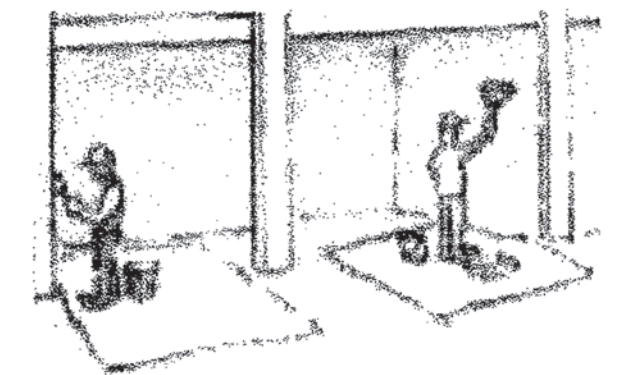

Painting Cleanup and Removal

- Never clean brushes or rinse paint containers into a street, gutter, storm drain, or stream.
- For water-based paints, paint out brushes to the extent possible, and rinse into a drain that goes to the sanitary sewer. Never pour paint down a storm drain.
- For oil-based paints, paint out brushes to the extent possible and clean with thinner or solvent in a proper container. Filter and reuse thinners and solvents. Dispose of excess liquids as hazardous waste.
- Paint chips and dust from non-hazardous dry stripping and sand blasting may be swept up or collected in plastic drop cloths and disposed of as trash.
- Chemical paint stripping residue and chips and dust from marine paints or paints containing lead, mercury, or tributyltin must be disposed of as hazardous waste. Lead based paint removal requires a state-certified contractor.

Dewatering

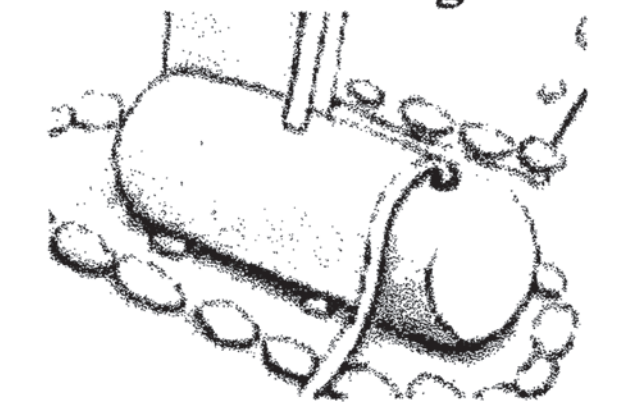

- Discharges of groundwater or captured runoff from dewatering operations must be properly managed and disposed. When possible send dewatering discharge to landscaped area or sanitary sewer. If discharging to the sanitary sewer call your local wastewater treatment plant.
- Divert run-on water from offsite away from all disturbed areas.
- When dewatering, notify and obtain approval from the local municipality before discharging water to a street gutter or storm drain. Filtration or diversion through a basin, tank, or sediment trap may be required.
- In areas of known or suspected contamination, call your local agency to determine whether the ground water must be tested. Pumped groundwater may need to be collected and hauled off-site for treatment and proper disposal.

Storm drain polluters may be liable for fines of up to \$10,000 per day!

NATIVE CALIFORNIA PLANTS (TO ENHANCE SITE BIODIVERSITY)

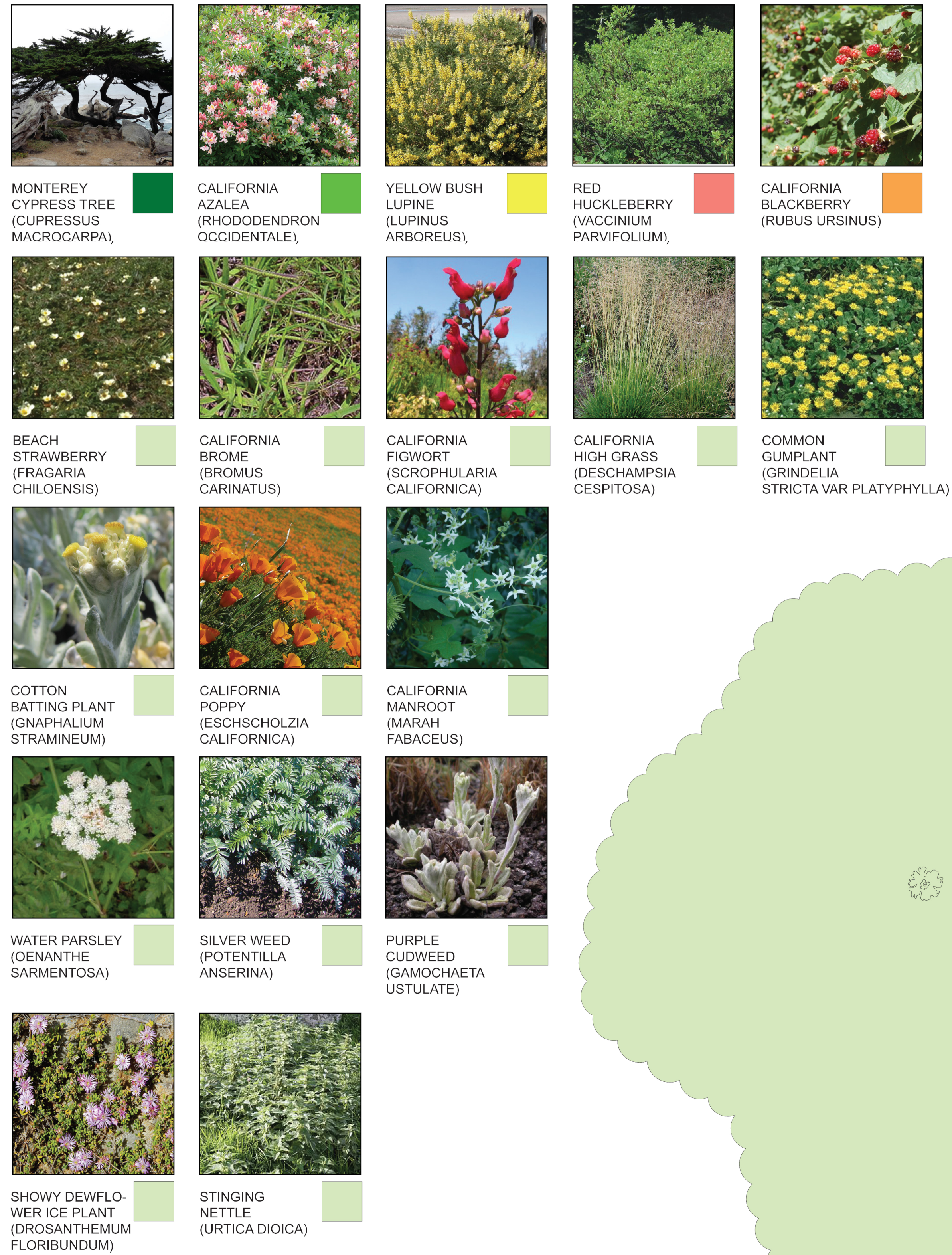

NOTES:

- 1- SPRINKLER SYSTEM TO BE DRIP IRRIGATION.
- 2- ALL PLANTING UTILIZED IS NATIVE AND EXISTING IN AREA (CLIMATE ADAPTED).
- 3- 2,400 SF OF IRRIGATED PLANTING BEDS (P-1 - P-8) WITH NATIVE PLANTING.
- 4- AREAS DISTURBED BY CONSTRUCTION ACTIVITY OUTSIDE OF PLANTING BEDS WILL BE RESEEDING WITH NATIVE GROUND COVER AS SPECIFIED.

- 5- COMPOST INCORPORATED IN PLANTING BEDS P-1 THROUGH P-8, AT A RATE OF AT LEAST 4 CUBIC YARDS PER 1,000 SF TO A DEPTH OF 6" INTO LANDSCAPE AREA.
- 6- A MIN 3" LAYER OF MULCH SHOULD BE APPLIED ON ALL EXPOSED SOIL SURFACES OF PLANTING AREAS IN PLANTING BEDS P-1 THROUGH P-8.
- 7- IRRIGATION CONTROLLERS USE EVAPOTRANSPIRATION OR SOIL MOISTURE DATA & UTILIZE A RAIN SENSOR.
- 8- IRRIGATION CONTROLLER PROGRAM DATA WILL NOT BE LOST DUE TO AN INTERRUPTION IN PRIMARY POWER SOURCE.
- 9- AREAS LESS THAN 10' IN ANY DIRECTION UTILIZE SUB-SURFACE OR DRIP IRRIGATION THAT PREVENTS OVERSPRAY OR RUN OFF.



LANDSCAPE PLAN
SCALE: 1/8" = 1'-0"

