

**COUNTY OF SAN MATEO
PLANNING AND BUILDING DEPARTMENT**

DATE: February 16, 2023

TO: Zoning Hearing Officer

FROM: Planning Staff

SUBJECT: Consideration of a Use Permit renewal, pursuant to Section 6500 of the County of San Mateo Zoning Regulations to allow the continued operation of a wireless telecommunications facility located northeast of the intersection of Tunitas Creek Road and Cabrillo Highway, at 21960 Cabrillo Highway in the unincorporated San Gregorio area of San Mateo County. The project is located within the Cabrillo Highway State Scenic Corridor.

County File Number: PLN 2011-00312 (Verizon Wireless)

PROPOSAL

The applicant, Verizon Wireless, proposes to renew its Use Permit for a co-located cellular communications facility on a 153-acre parcel at 21960 Cabrillo Highway in the unincorporated area of San Gregorio; the parcel is located northeast of the intersection of Tunitas Creek Road and Cabrillo Highway. The facility includes a 55-foot-high monopole, which supports two Sprint owned antennas four Verizon Wireless “stacked” antennas (two with a centerline height of 48 feet and two with a centerline height of 53 feet above ground). The facility also includes a ground level (Sprint) and an elevated equipment platform (Verizon), which support equipment cabinets, a fiber cabinet, and two GPS antennas, along with associated underground utility lines from existing services (power, telco, and coaxial cable).

RECOMMENDATION

That the Zoning Hearing Officer approve the Use Permit renewal, County File Number PLN 2011-00312, by adopting the required findings and conditions of approval identified in Attachment A.

BACKGROUND

Report Prepared By: Angela Chavez, Senior Planner

Applicant: Nicole Comach for Crown Castle on behalf of Verizon Wireless

Owner: Keith and Cynthia Waddell

Public Notification: Ten (10) day advanced notification for the hearing was mailed to property owners within 300 feet of the project parcel and a notice for the hearing posted in a newspaper (San Mateo Times and Half Moon Bay Review) of general public circulation.

Location: 21960 Cabrillo Highway, San Gregorio

APN: 066-330-160

Size: 153 acres

Existing Zoning: PAD/CD (Planned Agricultural District/Coastal Development)

General Plan Designation: Agriculture

Local Coastal Plan Designation: Agriculture

Existing Land Use: Cattle grazing, cellular site at project area; northeast portion of parcel includes single-family residential development approved by the California Coastal Commission.

Williamson Act: The subject parcel is under a Williamson Act contract approved by the San Mateo County Planning Commission on June 9, 1966 (County File Number AP 66 37).

Water Supply: N/A for proposed project; however, a private, on-site well serves the existing residential development.

Sewage Disposal: N/A for proposed project; however, a private, on-site septic system serves the existing residential development.

Flood Zone: The project site is located within Flood Zone X, areas of minimal flooding; Community Panel Number 06081C 0357F, effective August 2, 2017.

Environmental Evaluation: Exempt under Section 15301, Class 1, of the California Environmental Quality Act, which allows for the continued operation of an existing use.

Setting: The project parcel is located within the Cabrillo Highway State Scenic Corridor and abuts the eastern side of Cabrillo Highway approximately one-half mile north of Tunitas Creek Road. The 153-acre parcel is developed with a single-family residence and barn in the northeast portion of the property with access from Tunitas Creek Road. In addition, the cellular facility is located near the western side of the parcel, at the edge of a 50-foot-tall embankment overlooking Cabrillo Highway. An existing access road from Cabrillo Highway provides access to the facility. The remaining portions of the

parcel are undeveloped open space and used for cattle grazing. Numerous trees and topography between the project area and Cabrillo Highway help to screen the project site area from public views.

Chronology:

<u>Date</u>	<u>Action</u>
October 28, 2011	- Application submitted for a Coastal Development Permit, Planned Agricultural Permit, and Use Permit for Verizon Wireless co-location at existing Sprint cellular facility.
December 1, 2011	- Incomplete letter issued to applicant, after initial 30-day review period.
December 13, 2011	- Received "Fail" from Fire Department; access road turnout and turnaround improvements required.
March 23, 2012	- Tolling agreement between County and Verizon Wireless to extend Federal Communications Commission's (FCC) Ruling that a local government must act on an application to co-locate a wireless facility within 150 days. Agreement extends County's action to June 25, 2012.
April 6, 2012	- Received revised plans to address Fire Department review comments from December 13, 2011.
April 13, 2012	- Received confirmation from California Coastal Commission (CCC) that Coastal Development Permit Amendment from CCC required for proposed co-location, to include an amendment to the agricultural conservation easement.
April 23, 2012	- Received "Fail" from Fire Department; detail of turnout and weight capacities not shown on plans.
May 14, 2012	- Received email of revised plans to address Fire Department review comments from April 23, 2012.
May 15, 2012	- Planning review identified additional grading work that requires a grading permit. Notified applicant that additional application forms, fees and plans required for a grading permit to be added into project scope.
June 19, 2012	- Applicant requested an extension to the tolling agreement between the County and Verizon Wireless from June 25, 2012, to August 31, 2012.

- August 7, 2012 - Received revised plans to address Fire Department review comments and grading permit plan requirements from May 14, 2012, and April 23, 2012, respectively. Subsequently, received grading permit application forms on August 9, 2012, and grading permit application fees on August 22, 2012.
- August 8, 2012 - Referral of revised plans received on August 7, 2012 sent to San Mateo County Fire Department, Department of Public Works, and Geotechnical Section for review.
- August 24, 2012 - September 24, 2012 - Mitigated Negative Declaration public review period.
- August 28, 2012 - Applicant requested an extension to the tolling agreement between the County and Verizon Wireless from August 31, 2012, to October 10, 2012.
- September 10, 2012 - Review by Agricultural Advisory Committee.
- September 26, 2012 - Planning Commission approved the Use Permit.
- December 7, 2021 - Minor Modification approved to allow for the removal and replacement of antennas and cabinets.
- June 27, 2022 - Use Permit Renewal application received
- January 12, 2023 - Application deemed complete
- February 16, 2023 - Zoning Hearing Officer public hearing.

DISCUSSION

A. **KEY ISSUES**

1. **Conformance with the General Plan**

The project continues to conform with the applicable General Plan policies for Vegetative, Water, Fish, and Wildlife Resources, Soil Resources, Visual Quality, Historical and Archaeological, Rural Land Use, and Geotechnical Hazards as the project was constructed in accordance with its last approval and no physical changes to the existing facility are proposed at this time.

2. Conformance with Zoning Regulations

The project parcel is zoned PAD/CD (Planned Agricultural District/Coastal Development) and is designated as “Lands Suitable for Agriculture” by the County General Plan; the project parcel contains no prime soils. The existing wireless telecommunication facility is operating under a previously approved Use Permit and the project was constructed in accordance with approved plans. No physical changes are proposed. No complaints regarding the project have been received. The project remains consistent with the PAD/CD zoning district requirements.

3. Compliance with Wireless Telecommunications Facilities Ordinance (WTF)

The project continues to conform with the applicable standards of the Wireless Telecommunication Facilities (WTF) Ordinance, as discussed below:

a. Development and Design Standards

Section 6512.2 of the WTF ordinance discusses location, minimizing visual impacts, maximum height, and future co-location of wireless facilities. The project area is located within the Cabrillo Highway State Scenic Corridor. The existing facility does not obstruct scenic views as the project site is located on the east side of Cabrillo Highway approximately 50 feet above the roadway. While the approximately 5-10 feet of the pole/antennas are visible from limited public viewpoints the remainder of the facility is not visible from the scenic roadway due to the topography and existing tree cover. Based on the Radio Frequency emissions analysis completed by Sophie Thein of SiteSafe, LLC., composite exposure levels are at a spatial average of less than 1% of the Federal Communications Commission (FCC) general public exposure at public accessible areas for all facilities at this location. There is one other carrier present on the site but there are currently no further expansions are planned or anticipated at this time.

b. Performance Standards

The existing facility continues to be compliant with the required performance standards of Section 6512.3 for lighting, licensing, provision of a permanent power source, timely removal of the facility, visual resource protection, and generator use and maintenance. There is no lighting proposed, proper licenses have been obtained from both the FCC and CPUC, power for the facility is provided by PG&E (existing service), there is minimal visual impact, and conditions of approval continue to require maintenance and/or removal of the facility when necessary.

4. Conformance with Use Permit Findings

In order to approve the subject Use Permit Renewal, the Zoning Hearing Officer must make the following findings:

- a. *That the establishment, maintenance and/or conducting of the use will not, under the circumstances of the particular case, result in significant impacts to coastal resources, or be detrimental to the public welfare or injurious to property or improvements in the neighborhood.*

The subject wireless facility has been in operation since 2013 and has not resulted in any adverse impacts to the surrounding area. The radio frequency analysis submitted by the applicant indicates that the facility continues to comply with the FCC's current prevailing standards for limiting human exposure to RF energy. As this is an unmanned communication facility, the operation does not create additional traffic, noise, or intensity of use of the property.

- b. *That the telecommunication facilities are necessary for the public health, safety, convenience or welfare of the community.*

Staff found that the continued operation of the existing cellular facility at this location will allow for continued cellular communication coverage for private citizens and businesses. The existing wireless telecommunication facility has been in existence for many years and the community has come to rely on the coverage provided by this site. The site facilitates both routine daily conversation but also communication services in emergency situations.

5. Conformance with Conditions of Last Use Permit Approvals

Staff has reviewed the previous Use Permit conditions of approval for this permit, last approved 2012, and has determined that the project is in compliance with all previous conditions, see Attachment E. No physical changes are proposed as part of the renewal. Previous conditions that remain relevant, are included in Attachment A of this staff report.

B. ENVIRONMENTAL REVIEW

The project is categorically exempt pursuant per Section 15301, Class 1, of the CEQA Guidelines for the continued operation of existing public or private facilities involving no alterations or expansion of use as no physical changes are proposed.

C. REVIEWING AGENCIES

Department of Public Works
Coastside Fire Protection District
California Coastal Commission

ATTACHMENTS

- A. Recommended Findings and Conditions of Approval
- B. Location Map
- C. Plans
- D. Radio Frequency (RF) Report
- E. 2012 Letter of Decision

ACC:cmc: - ACCHH0017_WCU.DOCX

County of San Mateo
Planning and Building Department

RECOMMENDED FINDINGS AND CONDITIONS OF APPROVAL

Permit or Project File Number: PLN 2011-00312 Hearing Date: February 16, 2023

Prepared By: Angela Chavez,
Senior Planner

For Adoption By: Zoning Hearing Officer

RECOMMENDED FINDINGS

Regarding the Environmental Review, Find:

1. That the project is categorically exempt under provisions of Class 1, Section 15301 of the California Environmental Quality Act Guidelines, Existing Facilities. The proposed project includes the continued operation of an existing facility.

Regarding the Use Permit, Find:

2. That this personal telecommunications facility is necessary for the public health, safety, convenience or welfare of the community because the FCC has established the desirability and need for mobile and wireless telephone service to facilitate enhanced communication between mobile units. The subject cellular facility provides mobile and wireless services to all carriers of Verizon Wireless within the area and allows for unobstructed communication and cellular transmission between both private individuals and emergency/official vehicles. The range of personal communication services provided by this facility enhances telephone services in the area and is a necessary component of public health, safety, convenience and welfare. The cellular facility provides an efficient way to access this essential communication component, and thus, can be considered as necessary for the public health, safety, convenience and welfare.
3. That the establishment, maintenance and conducting of the use, as proposed and conditioned, will not result in significant impacts to coastal resources, or be detrimental to the public welfare or injurious to property or improvements in the neighborhood and will not be materially detrimental to the public welfare or injurious to property or improvements in the neighborhood as staff has reviewed the project file, referred the project to appropriate parties for comments, and reviewed previous conditions of approval and finds no issues concerning non-compliance with Current Planning Section requirements or issues from neighboring parcels in the vicinity. In addition, staff has reviewed the Radio Frequency report, and has found that the continued use of the existing facility is in

full conformance with the requirements of the Federal Communications Commission. The required findings for this project can be made.

RECOMMENDED CONDITIONS OF APPROVAL

Current Planning Section

1. The approval applies only to the proposal, documents, and plans described in this report and submitted and approved by the Zoning Hearing Officer on February 16, 2023. Minor modifications to the project may be approved by the Community Development Director if they are consistent with the intent of, and in substantial conformance with, this approval.
2. The Use Permit shall be valid for ten (10) years. Renewal of this permit shall be applied for six months prior to expiration, to the Planning and Building Department, and shall be accompanied by the renewal application and fees applicable at that time.
3. Any change in use or intensity not already approved shall require an amendment to the use permit. Amendment to this use permit requires an application for amendment, payment of applicable fees, and consideration at a public hearing.
4. Any future modifications to the approved facility or amendments to the use permit for this facility may require a Coastal Development Permit (Amendment) from the California Coastal Commission.
5. If a less visually obtrusive/reduced antenna technology becomes available for use during the life of this project, the applicant shall present a redesign incorporating this technology into the project for review by the Community Development Director and any parties that have expressed an interest. This installation shall be removed in its entirety at that time when this technology becomes obsolete, or this facility is no longer needed.
6. The applicant shall maintain all necessary licenses and registrations from the FCC and any other applicable regulatory bodies for the operation of the subject facility at this site. The applicant shall supply the Planning Department with evidence of such licenses and registrations. If any required license is ever revoked, the applicant shall inform the Planning Department of the revocation within ten (10) days of receiving notice of such revocation.
7. The applicant shall not enter into a contract with the landowner or lessee which reserves for one company exclusive use of the tower structure or the site for telecommunication facilities.

8. This facility and all equipment associated with it shall be removed in its entirety by the applicant within ninety (90) days if the FCC license and registration are revoked or if the facility is abandoned or no longer needed. The owner and/or operator of the facility shall notify the Planning Department upon abandonment of the facility.
9. There shall be no external lighting associated with this use. Wireless telecommunication facilities shall not be lighted or marked unless required by the FCC or Federal Aviation Administration (FAA).
10. This approved installation is to be dismantled and removed in its entirety from the property at that time when this technology becomes obsolete, or this facility is no longer needed.
11. The applicant shall maintain the approved gray color of the antennas and all associated tower mounted equipment to match the existing PG&E tower. The color of the GPS antenna shall also be maintained to match the fence and/or surrounding environment. Furthermore, all associated facility equipment shall be of non-reflective materials and/or colors.
12. Any necessary utilities leading to, or associated with, the facility shall be placed underground.
13. All ground disturbed areas shall be reseeded with native perennial grasses that are characteristic of coastal terrace prairie, including, but not limited to, oatgrass and purple needlegrass.

Cal-Fire

14. Existing private access road must be maintained. All potholes and any damaged roadway to be filled and compacted to 95% in order to support fire apparatus weighing 75,000 lbs. Gravel road access shall be certified by an engineer as to the compaction and weight it will support.
15. Emergency fire apparatus access shall be provided to within 150 feet of all exterior portions of the building. Surface shall be a minimum of twenty-foot-wide all-weather surface and shall be able to support a fire apparatus weighing a minimum of 75,000 lbs. An engineer's certification may be required for your project. Grades up to 15 % shall be a minimum of class 2 aggregate compacted to 95% or equivalent. All sections of emergency access road greater than 15% shall be paved with asphalt, concrete or equivalent, with a non-skid surface and a sub-base of class 2 aggregate, or equivalent, compacted to 95%. The driveway is over 150 feet in length and will need a fire engine turnaround approved by the San Mateo County Fire Department.

16. An approved fire access road with turnaround will be required for your project. This also requires access to all portions of your facilities. A copy of turnaround requirements will be included with this letter. Provide details of access and turnaround on plans.
17. A fuel break of defensible space is required around the perimeter of all structures, existing and new, to a distance of not less than 30 feet and may be required to a distance of 100 feet or to the property line. This is neither a requirement nor an authorization for the removal of living trees.
18. Trees located within the defensible space shall be pruned to remove dead and dying portions, and limbed up 6 feet above the ground. New trees planted in the defensible space shall be located no closer than 10 feet to adjacent trees when fully grown or at maturity.
19. Any gates or fences leading to the bridge will require a Knox lock or key switch. Please contact my office for the proper form if needed.
20. A Knox padlock or key switch will be required if there is limited access to property. CFC 506.1. For application and instructions please email smcfdfiremarshal@fire.ca.gov or if you need further assistance, please contact the San Mateo County Fire Marshal's Office at 650/573- 3846.
21. Gates shall be a minimum of 2 feet wider than the access road/driveway they serve. Overhead gate structures shall have a minimum of 15 feet of vertical clearance. Locked gates shall be provided with a Knox Box or Knox Padlock. Electric gates shall have a Knox Key Switch. Electric gates shall automatically open during power failures. CFC 503.6, 506. For application and instructions please email smcfdfiremarshal@fire.ca.gov if you need further assistance, please contact the San Mateo County Fire Marshal's Office at 650/573-3846.

ACC:cmc: - ACCHH0017_WCU.DOCX



COUNTY OF SAN MATEO - PLANNING AND BUILDING DEPARTMENT

ATTACHMENT B

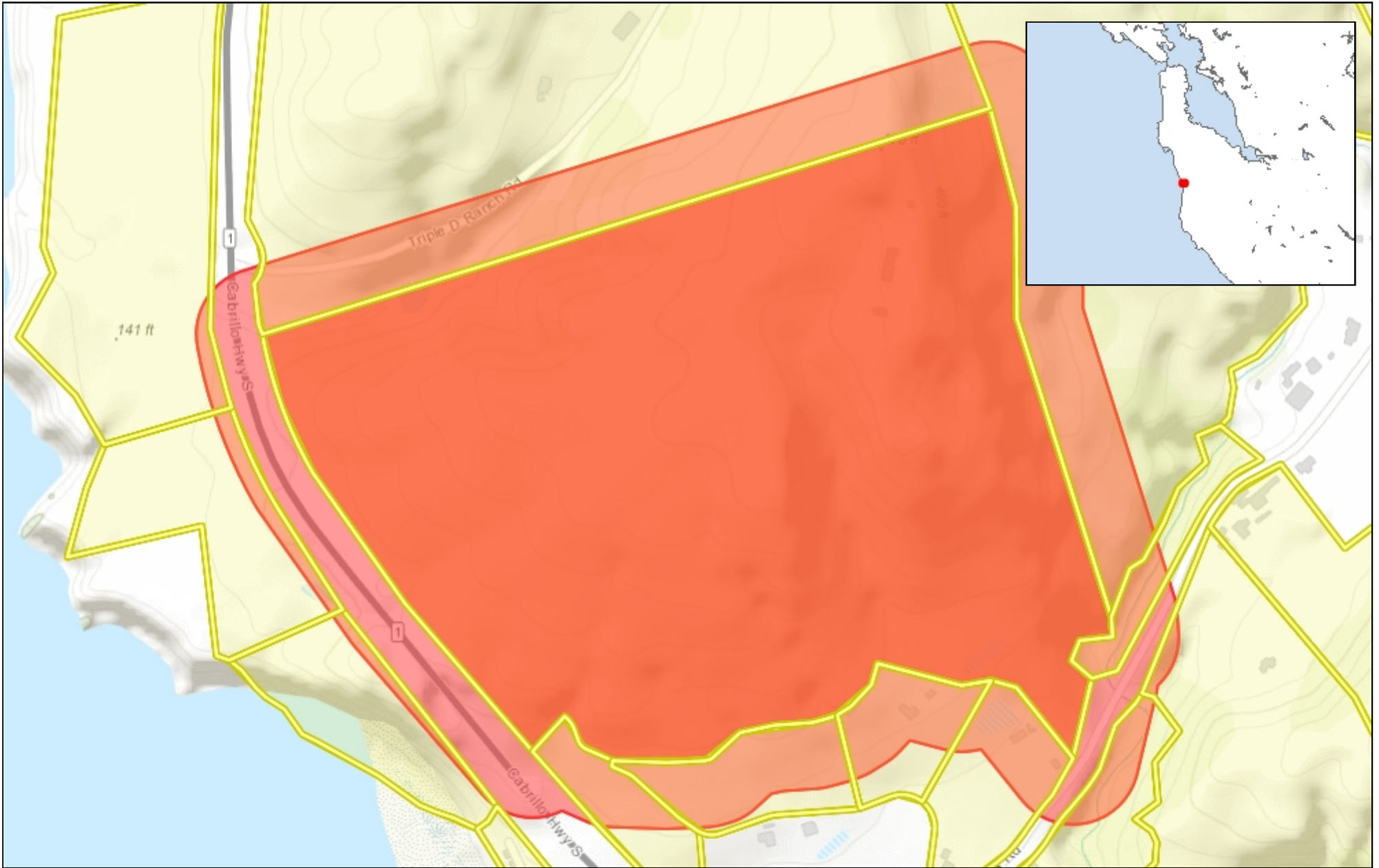

0.28 0 0.14 0.28 Miles

WGS_1984_Web_Mercator_Auxiliary_Sphere
© Latitude Geographics Group Ltd.

1:9,028



This map is a user generated static output from an Internet mapping site and is for reference only. Data layers that appear on this map may or may not be accurate, current, or otherwise reliable.

THIS MAP IS NOT TO BE USED FOR NAVIGATION



COUNTY OF SAN MATEO - PLANNING AND BUILDING DEPARTMENT

ATTACHMENT C



SITE NAME: TUNITAS BEACH
SITE TYPE: MONOPOLE
TOWER HEIGHT: 55'-0"

BUSINESS UNIT #: 880473
SITE ADDRESS: 21960 CABRILLO HWY S.
 HALF MOON BAY, CA 94019
COUNTY: SAN MATEO
JURISDICTION: SAN MATEO COUNTY

JURISDICTIONAL APPROVAL:

CROWN CASTLE
 1505 WESTLAKE AVENUE NORTH, SUITE 800
 SEATTLE, WA 98109

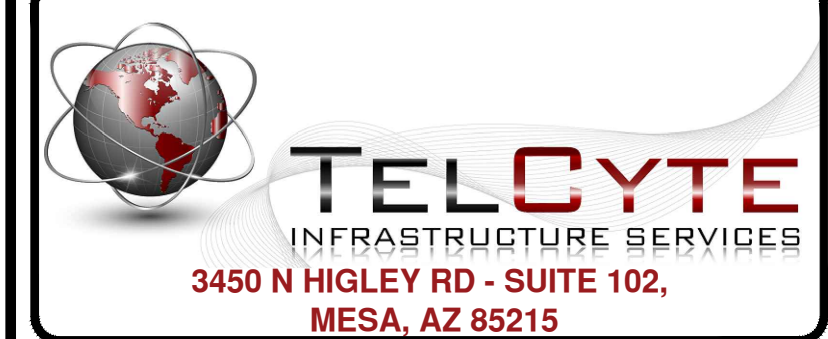

BU #: 880473
TUNITAS BEACH
 21960 CABRILLO HWY S.
 HALF MOON BAY, CA 94019
 EXISTING 55'-0" MONOPOLE

ISSUED FOR:

REV	DATE	DRWN	DESCRIPTION	DES./QA
0	06/23/22	MM	CUP RENEWAL	JD

SITE INFORMATION

CROWN CASTLE USA INC. TUNITAS BEACH
 SITE NAME:
 SITE ADDRESS: 21960 CABRILLO HWY S.
 HALF MOON BAY, CA 94019
 COUNTY: SAN MATEO
 MAP/PARCEL #: 066-330-160
 AREA OF CONSTRUCTION: EXISTING
 LATITUDE: 37.362864
 LONGITUDE: -122.401431
 LAT/LONG TYPE: NAD83
 GROUND ELEVATION: 323'-7"
 CURRENT ZONING: PAD, CD
 JURISDICTION: SAN MATEO COUNTY
 OCCUPANCY CLASSIFICATION: U
 TYPE OF CONSTRUCTION: IIB
 A.D.A. COMPLIANCE: FACILITY IS UNMANNED AND NOT FOR
 HUMAN HABITATION
 PROPERTY OWNER: KEITH AND CYNTHIA WADDELL
 300 TUNITAS CREEK LANE
 HALF MOON BAY, CA 94019
 TOWER OWNER/APPLICANT: CROWN CASTLE
 2000 CORPORATE DRIVE
 CANONSBURG, PA 15317
 ELECTRIC PROVIDER: PACIFIC GAS & ELECTRIC
 800-743-5000
 TELCO PROVIDER: ATT
 611

DRAWING INDEX

SHEET #	SHEET DESCRIPTION
T-1	TITLE SHEET
C-1.1	OVERALL SITE PLAN
C-1.2	SITE PLAN
C-2	EXISTING ELEVATION
C-3	EXISTING ANTENNA PLAN & SCHEDULE
C-4	EXISTING ANTENNA PLAN & SCHEDULE

ALL DRAWINGS CONTAINED HEREIN ARE FORMATTED FOR 22X34. CONTRACTOR SHALL VERIFY ALL PLANS AND EXISTING DIMENSIONS AND CONDITIONS ON THE JOB SITE AND SHALL IMMEDIATELY NOTIFY THE ENGINEER IN WRITING OF ANY DISCREPANCIES BEFORE PROCEEDING WITH THE WORK OR BE RESPONSIBLE FOR SAME.

PROJECT DESCRIPTION

CROWN CASTLE PROPOSES TO RENEW THE SPECIAL USE PERMIT FOR AN EXISTING WIRELESS COMMUNICATION FACILITY.

- NO CHANGES ARE PROPOSED TO THE PROJECT.

NOTE:
 PRIOR TO ACCESSING/ENTERING THE SITE YOU MUST CONTACT THE CROWN NOC AT (800) 788-7011 & CROWN CONSTRUCTION MANAGER

LOCATION MAP

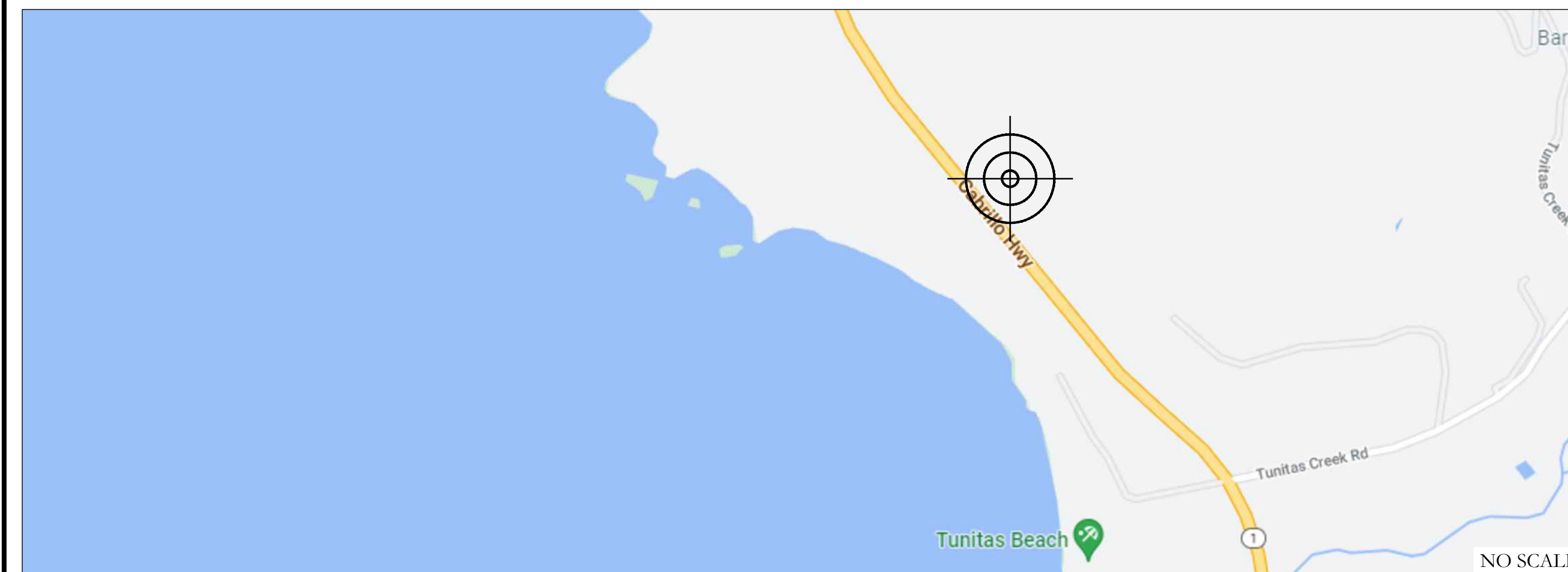

FROM SAN FRANCISCO INTERNATIONAL AIRPORT. GET ON US-101 S FROM AIRPORT ACCESS RD AND INTERNATIONAL TERMINAL ARRIVALS LEVEL (1.3 MI). HEAD SOUTHWEST ON AIRPORT ACCESS RD 0.2 MI. CONTINUE STRAIGHT TO STAY ON AIRPORT ACCESS RD 0.1 MI. SLIGHT LEFT ONTO INTERNATIONAL TERMINAL ARRIVALS LEVEL 0.1 MI. KEEP LEFT TO STAY ON INTERNATIONAL TERMINAL ARRIVALS LEVEL 0.3 MI. MERGE ONTO US-101 S VIA THE RAMP TO SAN JOSE 0.5 MI. FOLLOW US-101 S AND CA-92 W TO CA-1 S/CABRILLO HWY S (27.3 MI). MERGE ONTO US-101 S 6.5 MI. TAKE EXIT 414B TO MERGE ONTO CA-92 W TOWARD HALF MOON BAY 7.9 MI. KEEP LEFT TO CONTINUE ON CA-35/CA-92 W 5.2 MI. USE THE LEFT 2 LANES TO TURN LEFT ONTO CA-1 S/CABRILLO HWY S. DESTINATION WILL BE ON THE LEFT

APPLICABLE CODES/REFERENCE DOCUMENTS

ALL WORK SHALL BE PERFORMED AND MATERIALS INSTALLED IN ACCORDANCE WITH THE CURRENT EDITIONS OF THE FOLLOWING CODES AS ADOPTED BY THE LOCAL GOVERNING AUTHORITIES. NOTHING IN THESE PLANS IS TO BE CONSTRUED TO PERMIT WORK NOT CONFORMING TO THESE CODES:

CODE TYPE	CODE
BUILDING	2019 CBC (2018 IBC W/AMMENDMENTS)
MECHANICAL	2019 CMC (2018 IMC W/AMMENDMENTS)
ELECTRICAL	2019 CEC (2017 NEC W/AMMENDMENTS)
FIRE	2019 CFC (2018 IFC W/AMMENDMENTS)

PROJECT TEAM

A&E FIRM: TELCYTE INFRASTRUCTURE SERVICES
 3450 N HIGLEY RD, SUITE 102
 MESA, AZ 85215
 CWOLFE@TELCYTE.COM
 CROWN CASTLE USA INC. DISTRICT CONTACTS:
 4301 HACIENDA DRIVE, SUITE 410
 PLEASANTON, CA 94588
 CAMPBELL A&Z, LLC - ENTITLEMENT CONSULTANT
 MICHAEL J CAMPBELL
 602-616-8396
 CAMPBELLAZ1@EARTHLINK.NET

IT IS A VIOLATION OF LAW FOR ANY PERSON, UNLESS THEY ARE ACTING UNDER THE DIRECTION OF A LICENSED PROFESSIONAL ENGINEER, TO ALTER THIS DOCUMENT.

SHEET NUMBER: T-1
REVISION: 0

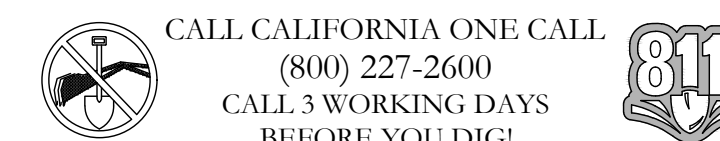

CALL CALIFORNIA ONE CALL
 (800) 227-2600
 CALL 3 WORKING DAYS
 BEFORE YOU DIG!

SITE PLAN DISCLAIMER:
 PROPERTY LINES AND STRUCTURES HAVE BEEN DIGITIZED FROM GOOGLE MAPS. CROWN CASTLE USA INC. HAS NOT COMPLETED A SITE SURVEY AND THEREFORE MAKES NO CLAIMS AS TO THE ACCURACY OF INFORMATION DEPICTED ON THIS SHEET.

JURISDICTIONAL APPROVAL:

CROWN CASTLE
 1505 WESTLAKE AVENUE NORTH, SUITE 800
 SEATTLE, WA 98109

TEL CYTE
 INFRASTRUCTURE SERVICES
 3450 N HIGLEY RD - SUITE 102,
 MESA, AZ 85215

BU #: 880473
TUNITAS BEACH
 21960 CABRILLO HWY S.
 HALF MOON BAY, CA 94019
 EXISTING 55'-0" MONOPOLE

ISSUED FOR:

REV	DATE	DRWN	DESCRIPTION	DES./QA
0	06/23/22	MM	CUP RENEWAL	JD

IT IS A VIOLATION OF LAW FOR ANY PERSON, UNLESS THEY ARE ACTING UNDER THE DIRECTION OF A LICENSED PROFESSIONAL ENGINEER, TO ALTER THIS DOCUMENT.

SHEET NUMBER:
C-1.1

REVISION:
0



1 OVERALL SITE PLAN
 SCALE: 1" = 200'-0" (FULL SIZE)
 1" = 400'-0" (11x17)

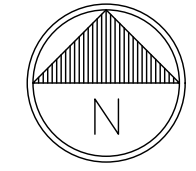

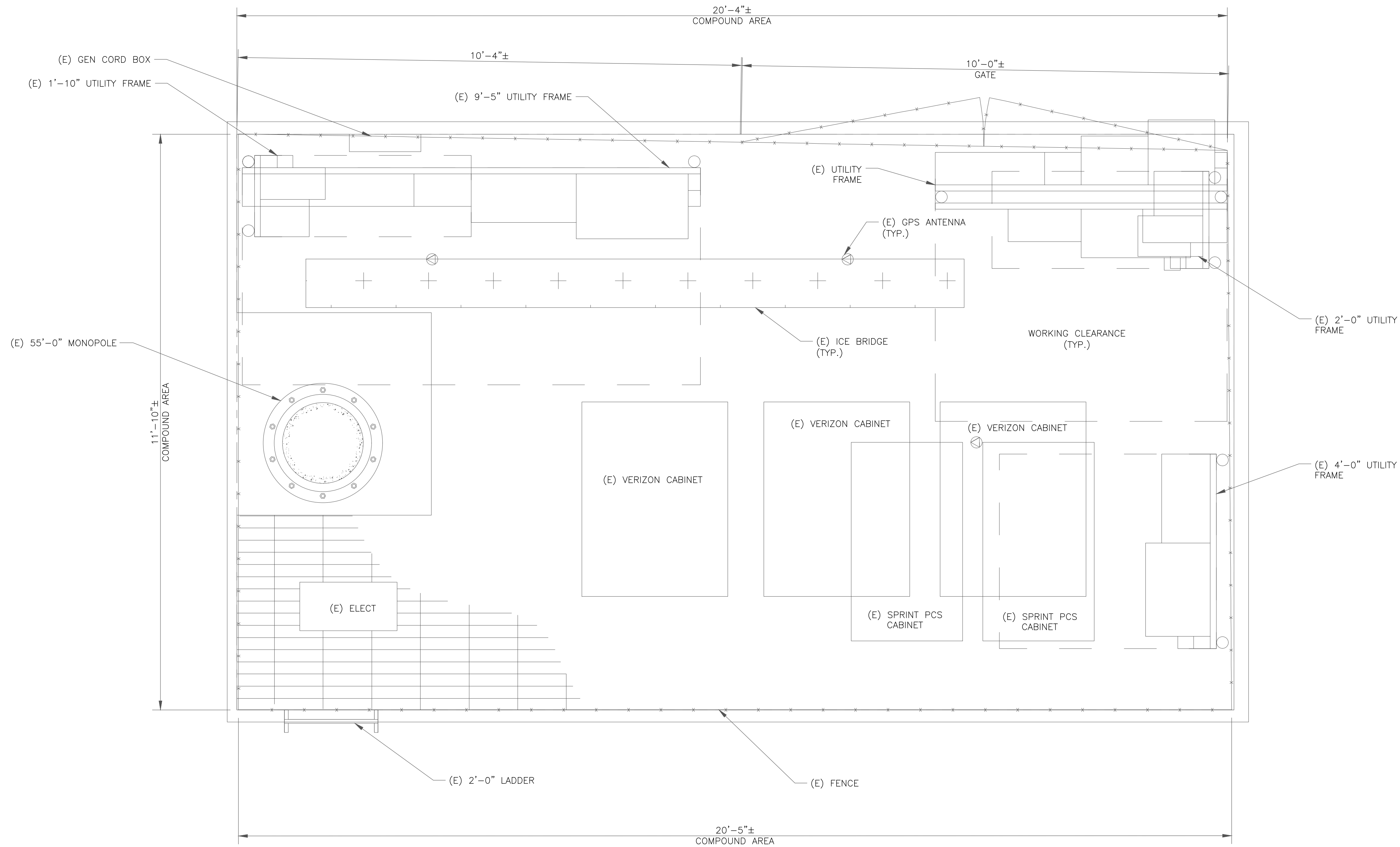

JURISDICTIONAL APPROVAL:

CROWN CASTLE
 1505 WESTLAKE AVENUE NORTH, SUITE 800
 SEATTLE, WA 98109

TELCYTE
 INFRASTRUCTURE SERVICES
 3450 N HIGLEY RD - SUITE 102,
 MESA, AZ 85215

BU #: 880473
TUNITAS BEACH
 21960 CABRILLO HWY S.
 HALF MOON BAY, CA 94019
 EXISTING 55'-0" MONOPOLE

ISSUED FOR:

REV	DATE	DRWN	DESCRIPTION	DES./QA
0	06/23/22	MM	CUP RENEWAL	JD

IT IS A VIOLATION OF LAW FOR ANY PERSON,
 UNLESS THEY ARE ACTING UNDER THE DIRECTION
 OF A LICENSED PROFESSIONAL ENGINEER,
 TO ALTER THIS DOCUMENT.

SHEET NUMBER: **C-1.2** REVISION: **0**

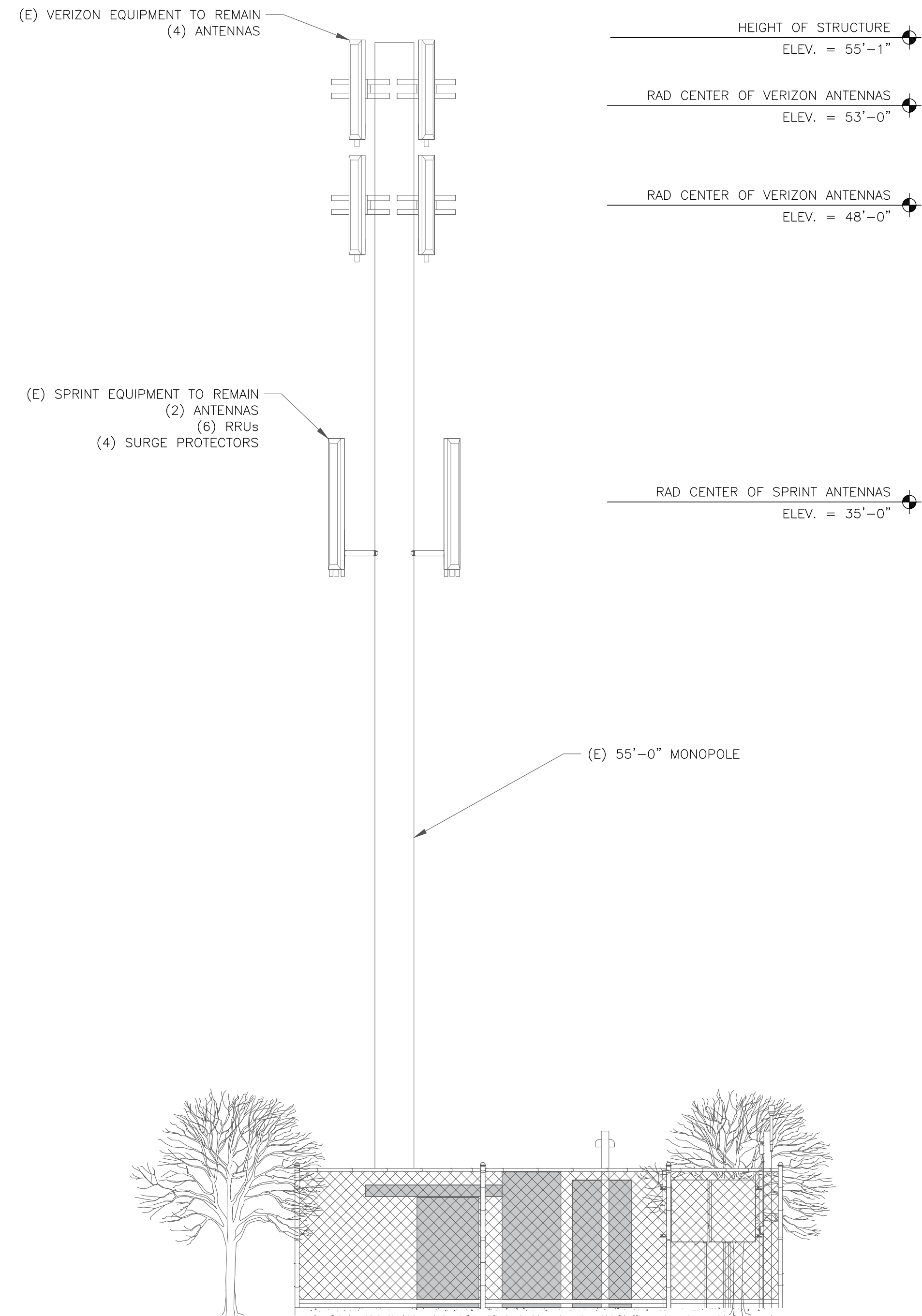

1 EXISTING ELEVATION
SCALE: NOT TO SCALE

JURISDICTIONAL APPROVAL:

CROWN CASTLE
1505 WESTLAKE AVENUE NORTH, SUITE 800
SEATTLE, WA 98109

TELCYTE
INFRASTRUCTURE SERVICES
3450 N HIGLEY RD - SUITE 102,
MESA, AZ 85215

BU #: 880473
TUNITAS BEACH
21960 CABRILLO HWY S.
HALF MOON BAY, CA 94019
EXISTING 55'-0" MONOPOLE

ISSUED FOR:

REV	DATE	DRWN	DESCRIPTION	DES./QA
0	06/23/22	MM	CUP RENEWAL	JD

IT IS A VIOLATION OF LAW FOR ANY PERSON,
UNLESS THEY ARE ACTING UNDER THE DIRECTION
OF A LICENSED PROFESSIONAL ENGINEER,
TO ALTER THIS DOCUMENT.

SHEET NUMBER:
C-2

REVISION:
0

EQUIPMENT SCHEDULE

ALPHA																			
POSITION	ANTENNA					RADIO			DIPLEXER			TMA		SURGE PROTECTION		CABLES			
	CARRIER	STATUS/MANUFACTURER	MODEL	AZIMUTH	RAD CENTER	QTY.	STATUS/MODEL	LOCATION	QTY.	STATUS	LOCATION	QTY.	STATUS	QTY.	STATUS/MODEL	QTY.	STATUS/TYPE	SIZE	LENGTH
A1	SPRINT	(E) KMW ETCR-654L12H6		NA	35'-0"	1 1 1	(E) RRH-B8 (E) RFD01F-26A (E) RRH-P4 PH1	TOWER TOWER TOWER	-	-	-	-	-	1 1	POWER JUNCTION OPTICAL JUNCTION	1	COAX	1-1/4"	55'-0"

BETA																			
POSITION	ANTENNA					RADIO			DIPLEXER			TMA		SURGE PROTECTION		CABLES			
	CARRIER	STATUS/MANUFACTURER	MODEL	AZIMUTH	RAD CENTER	QTY.	STATUS/MODEL	LOCATION	QTY.	STATUS	LOCATION	QTY.	STATUS	QTY.	STATUS/MODEL	QTY.	STATUS/TYPE	SIZE	LENGTH
B1	SPRINT	(E) KMW ETCR-654L12H6		NA	35'-0"	1 1 1	(E) RRH-B8 (E) RFD01F-26A (E) RRH-P4 PH1	TOWER TOWER TOWER	-	-	-	-	-	1 1	POWER JUNCTION OPTICAL JUNCTION	1	COAX	1-1/4"	55'-0"

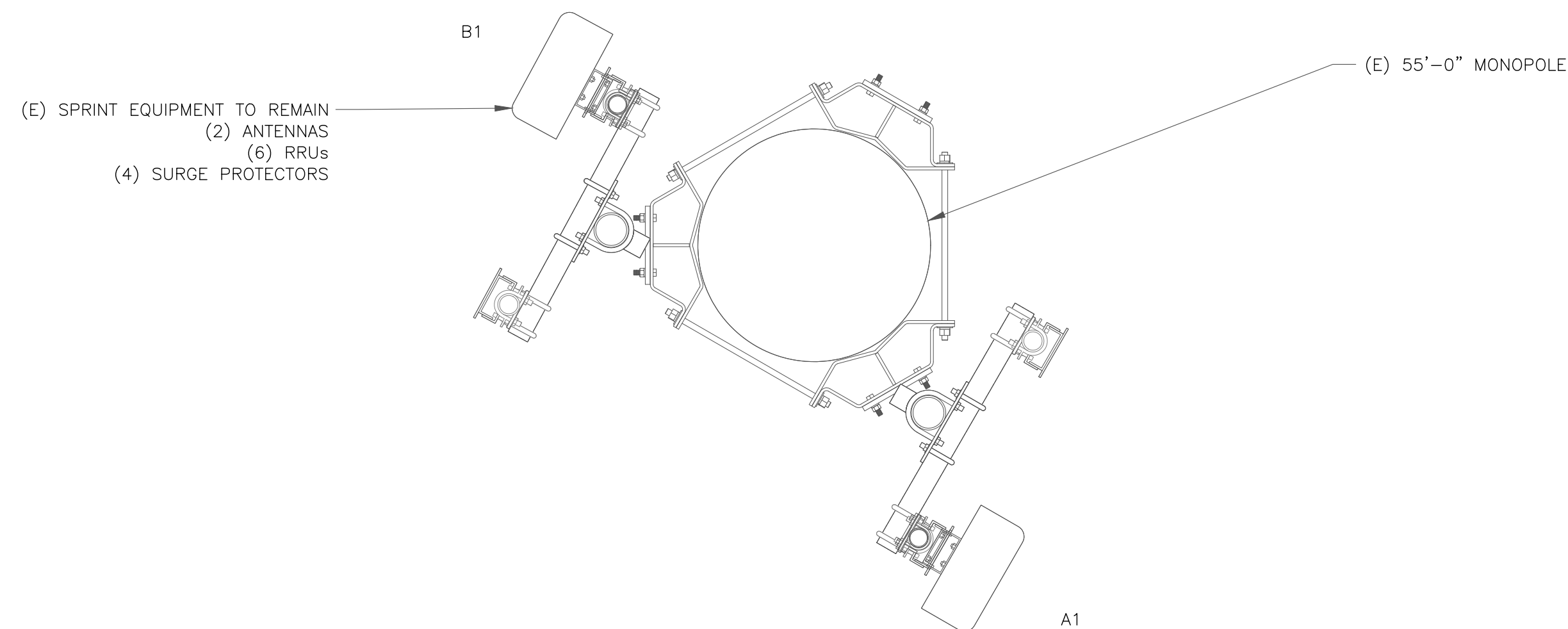

1 EXISTING SPRINT ANTENNA PLAN @35'-0"
SCALE: NOT TO SCALE

JURISDICTIONAL APPROVAL:

CROWN CASTLE
1505 WESTLAKE AVENUE NORTH, SUITE 800
SEATTLE, WA 98109

TELCYTE
INFRASTRUCTURE SERVICES
3450 N HIGLEY RD - SUITE 102,
MESA, AZ 85215

BU #: 880473
TUNITAS BEACH
21960 CABRILLO HWY S.
HALF MOON BAY, CA 94019
EXISTING 55'-0" MONOPOLE

ISSUED FOR:				
REV	DATE	DRWN	DESCRIPTION	DES./QA
0	06/23/22	MM	CUP RENEWAL	JD

IT IS A VIOLATION OF LAW FOR ANY PERSON,
UNLESS THEY ARE ACTING UNDER THE DIRECTION
OF A LICENSED PROFESSIONAL ENGINEER,
TO ALTER THIS DOCUMENT.

SHEET NUMBER: C-3	REVISION: 0
---	---

JURISDICTIONAL APPROVAL:

EQUIPMENT SCHEDULE

ALPHA																		
POSITION	ANTENNA				RADIO				DIPLEXER		TMA		SURGE PROTECTION		CABLES			
	CARRIER	STATUS/MANUFACTURER MODEL	AZIMUTH	RAD CENTER	QTY.	STATUS/MODEL	LOCATION	QTY.	STATUS	LOCATION	QTY.	STATUS	QTY.	STATUS/MODEL	QTY.	STATUS/TYPE	SIZE	LENGTH
A1	VERIZON	(E) ANDREW DBXNH-6565A-R2M	0°	48'-0"	-	-	-	-	-	-	-	-	-	-	2	COAX	7/8"	68'-0"
A2	VERIZON	(E) ANDREW DBXNH-6565A-R2M	0°	53'-0"	-	-	-	-	-	-	-	-	-	-	2	COAX	7/8"	73'-0"
BETA																		
B1	VERIZON	(E) ANDREW DBXNH-6565A-R2M	110°	48'-0"	-	-	-	-	-	-	-	-	-	-	2	COAX	7/8"	68'-0"
B2	VERIZON	(E) ANDREW DBXNH-6565A-R2M	110°	53'-0"	-	-	-	-	-	-	-	-	-	-	2	COAX	7/8"	73'-0"

CROWN CASTLE
 1505 WESTLAKE AVENUE NORTH, SUITE 800
 SEATTLE, WA 98109

TELCYTE
 INFRASTRUCTURE SERVICES
 3450 N HIGLEY RD - SUITE 102,
 MESA, AZ 85215

BU #: 880473
TUNITAS BEACH
 21960 CABRILLO HWY S.
 HALF MOON BAY, CA 94019
 EXISTING 55'-0" MONOPOLE

ISSUED FOR:

REV	DATE	DRWN	DESCRIPTION	DES/QA
0	06/23/22	MM	CUP RENEWAL	JD

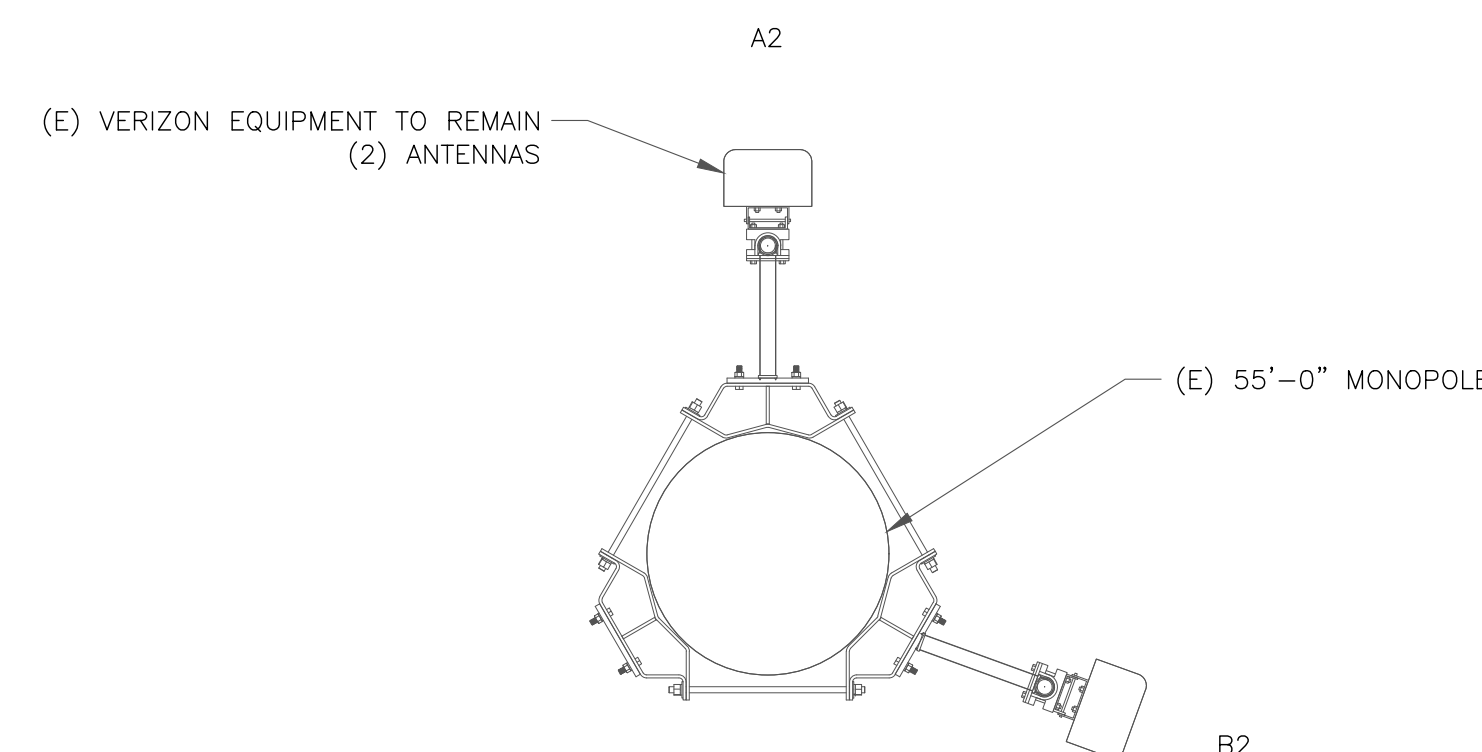
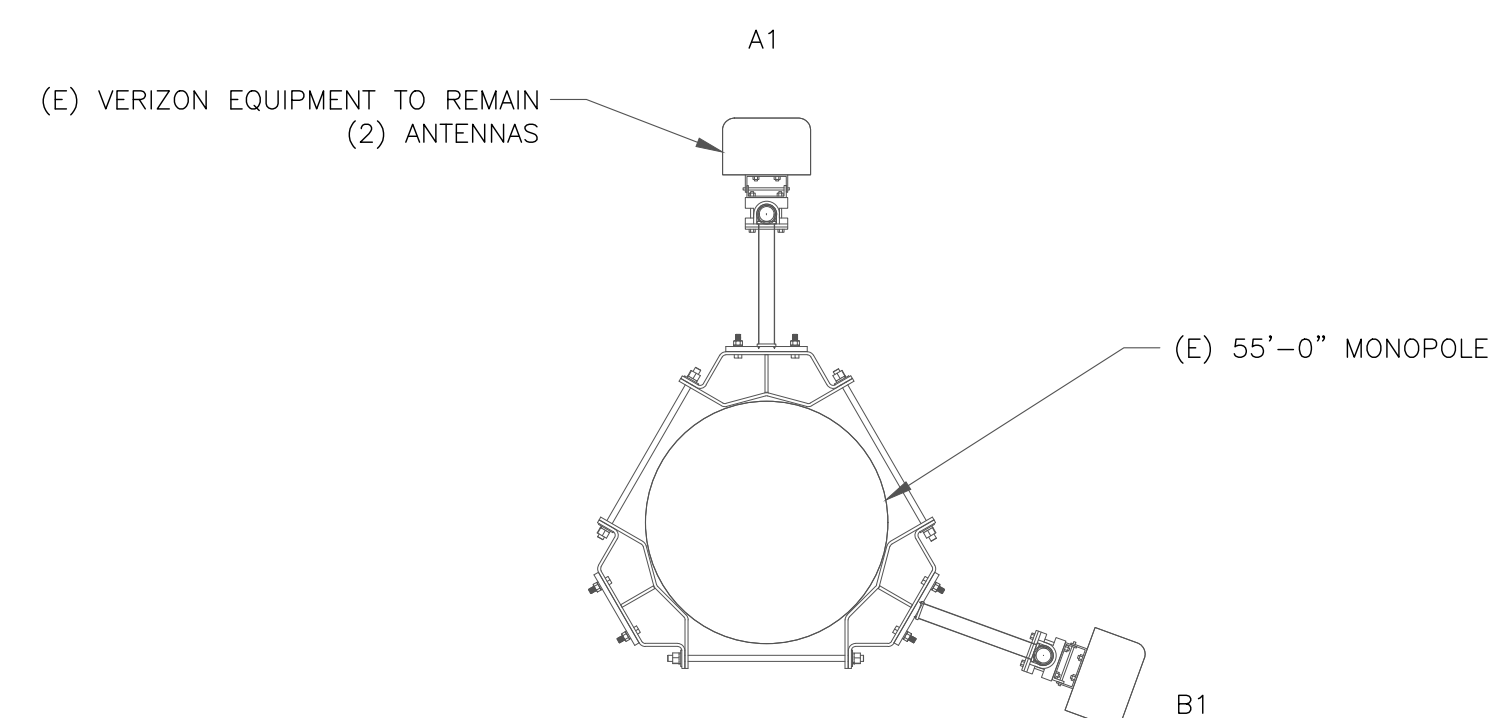

1 EXISTING VERIZON ANTENNA PLAN @48'-0"
 SCALE: NOT TO SCALE

2 EXISTING VERIZON ANTENNA PLAN @53'-0"
 SCALE: NOT TO SCALE

IT IS A VIOLATION OF LAW FOR ANY PERSON, UNLESS THEY ARE ACTING UNDER THE DIRECTION OF A LICENSED PROFESSIONAL ENGINEER, TO ALTER THIS DOCUMENT.

SHEET NUMBER: **C-4** REVISION: **0**



COUNTY OF SAN MATEO - PLANNING AND BUILDING DEPARTMENT

ATTACHMENT D

Crown Castle
Site ID – 880473
Assessment Purpose – CUP Renewal
Site Name – TUNITAS BEACH
Site Compliance Report

ANH-1, Hwy 1, 2, 100' N/O
Tunitas Creek, CA 94019

Latitude: N37-21-46.31
Longitude: W122-24-05.15
Structure Type: Monopole

Report generated date: January 20, 2023
Report by: Sophie Thein
Customer Contact: Jim Lee

**Crown Castle is compliant with the FCC Rules
and Regulations.**

© 2023 Site Safe, LLC, Vienna, VA



sealed 20jan2023

Crown Castle TUNITAS BEACH - 880473 Radio Frequency (RF) Site Compliance Report



ANH-1, Hwy 1, 2, 100' N/O, Tunitas Creek, CA 94019



Table of Contents

1	EXECUTIVE SUMMARY	3
2	SITE COMPLIANCE	4
	2.1 SITE COMPLIANCE STATEMENT.....	4
	2.2 ACTIONS FOR SITE COMPLIANCE.....	4
3	ANALYSIS	5
	3.1 RF EXPOSURE DIAGRAM	5
4	ANTENNA INVENTORY	7
5	ENGINEER CERTIFICATION	9
	APPENDIX A – STATEMENT OF LIMITING CONDITIONS	10
	APPENDIX B – ASSUMPTIONS AND DEFINITIONS	11
	GENERAL MODEL ASSUMPTIONS	11
	DEFINITIONS.....	12
	APPENDIX C – RULES & REGULATIONS	14
	EXPLANATION OF APPLICABLE RULES AND REGULATIONS.....	14
	OCCUPATIONAL ENVIRONMENT EXPLAINED.....	14
	APPENDIX D – GENERAL SAFETY RECOMMENDATIONS	15
	ADDITIONAL INFORMATION	16
	APPENDIX E – REGULATORY BASIS	17
	FCC RULES AND REGULATIONS	17
	APPENDIX F – SAFETY PLAN AND PROCEDURES	19



1 Executive Summary

Crown Castle has contracted with Site Safe, LLC (Sitesafe), an independent Radio Frequency (RF) regulatory and engineering consulting firm, to determine whether the communications site, 880473 - TUNITAS BEACH, located at ANH-1, Hwy 1, 2, 100' N/O, Tunitas Creek, CA, is in compliance with the Federal Communications Commission (FCC) Rules and Regulations for RF exposure.

This report contains a detailed summary of the RF environment at the site including:

- Diagram of the site
- Inventory of the make / model of all antennas
- Theoretical MPE based on modeling

This report addresses exposure to radio frequency electromagnetic fields in accordance with the FCC Rules and Regulations for all individuals, classified in two groups, "Occupational or Controlled" and "General Public or Uncontrolled."

Crown Castle is compliant with the FCC Rules and Regulations, as described in OET Bulletin 65.

This document and the conclusions herein are based on the information provided by Crown Castle.

If you have any questions regarding RF safety and regulatory compliance, please do not hesitate to contact Sitesafe's Customer Support Department at (703) 276-1100.

2 Site Compliance

2.1 Site Compliance Statement

Upon evaluation of the cumulative RF exposure levels from all operators at this site, Sitesafe has determined that:

Crown Castle is compliant with the FCC Rules and Regulations, as described in OET Bulletin 65.

The compliance determination is based on theoretical modeling, RF signage placement recommendations, and/or the level of restricted access to the antennas at the site. Any deviation from the existing Crown Castle deployment plan could result in the site being rendered non-compliant upon further evaluation.

2.2 Actions for Site Compliance

Based on common industry practice and our understanding of FCC and OSHA requirements, this section provides a statement of recommendations for site compliance. No additional RF alert signage recommendations have been proposed based on theoretical analysis of MPE levels. Where applicable, barriers can consist of locked doors, fencing, railing, rope, chain, paint striping or tape, combined with RF alert signage.

Crown Castle is compliant with the FCC Rules and Regulations.

Note: For overall compliance, access to the site (i.e., access road, gate, climbing point(s), etc.) must be locked/restricted.

Note: Ensure all existing signage documented in this report still exist on site unless otherwise indicated.

3 Analysis

3.1 RF Exposure Diagram

The RF diagram(s) below display theoretical percentage of the Maximum Permissible Exposure for all systems at the site. These diagrams use modeling as prescribed in OET Bulletin 65 and assumptions detailed in Appendix B.

The key at the bottom of each diagram indicates if percentages displayed are referenced to FCC **General Public** Maximum Permissible Exposure (MPE) limits. Color coding on the diagram is as follows:



This table displays the maximum theoretical percentage of the FCC’s General Public MPE limits:

General Public Levels:	
Exposure Type:	Spatial Average
Reference Level:	Ground
Composite:	<1.0%

Note: On the diagrams shown below, each level is marked with a height. For all diagrams that are marked as *Spatially Averaged*, the modeling program will spatially average the exposure within the area six feet above each set level. This provides an accurate spatial average of the percentage of the FCC’s MPE limits within an accessible area.

In the RF exposure simulations below, all heights are reflected with respect to ground level. Each different area, rooftop, or platform level is labeled with its height relative to the main site level. Exposure is calculated appropriately based on the relative height and location of that area to all antennas. The analyzed elevations in the RF exposure simulations are as follows:

- GROUND LEVEL = 0'
- MONOPOLE = 55'

RF Exposure Simulation For: TUNITAS BEACH Composite View

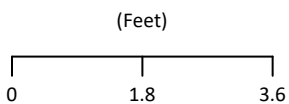
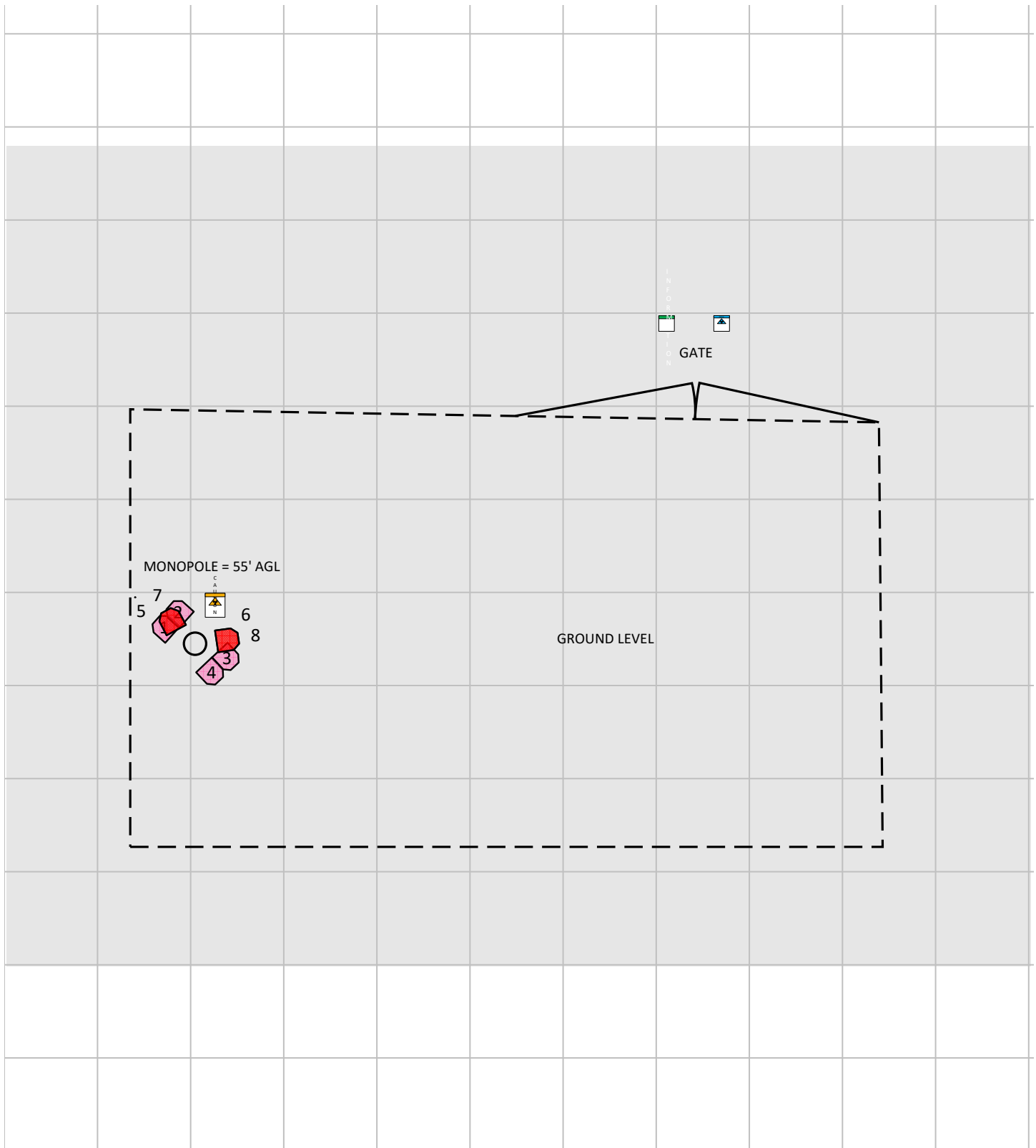

www.sitesafe.com
1/20/2023 2:16:35 PM

% of FCC Public Exposure Limit						
0-5	5-100	100-500	500-5000	5000+		
Barrier Signage Legend						
 No-sign	 Notice	 Caution	 Warning	 Notice 2	 Caution 2	 Warning 2
Existing Barrier		Proposed Barrier/Sign		Remove Barrier/Sign		

Sitesafe OET-65 Model
Near Field Boundary:
1.5 * Aperture
Reflection Factor: 1
Spatially Averaged

4 Antenna Inventory

The Antenna Inventory shows all transmitting antennas at the site. This inventory was provided by the customer and was utilized by Sitesafe to perform theoretical modeling of RF exposure. The inventory coincides with the site diagrams in this report, identifying each antenna's location at 880473 - TUNITAS BEACH. The antenna information collected includes the following information:

- Licensee or wireless operator name
- Frequency or frequency band
- Transmitter power – Transmitter Power Output ("TPO"), Effective Radiated Power ("ERP"), or Equivalent Isotropic Radiated Power ("EIRP")
- Antenna manufacturer make, model, and gain

Equipment, antenna models and nominal transmit power were used for modeling, based on past experience with radio service providers or data provided by Crown Castle.



The following antenna inventory was provided by the customer and was utilized to create the site model diagrams:

Ant ID	Operator	Antenna Make and Model	Type	TX Freq (MHz)	Technology	Az (Deg)	Hor BW (Deg)	Ant Len (ft)	Ant Gain (dBd)	Power	Power Type	Power Units	TX Count	Misc Loss	Total ERP (Watts)	Z (ft)	MDT (Deg)	EDT (Deg)
1	SPRINT (T-MOBILE)	Ericsson AIR6449 (T-Mobile B41)	Panel	2500	LTE	340	12.5	2.8	22.65	160.00	TPO	Watt	1	0.00	29452.35	34	0	0
1	SPRINT (T-MOBILE)	Ericsson AIR6449 (T-Mobile B41)	Panel	2500	5G	340	12.5	2.8	22.65	160.00	TPO	Watt	1	0.00	29452.35	34	0	0
2	SPRINT (T-MOBILE)	RFS APXVAALL24_43-U-NA20	Panel	1900	LTE	340	64.9	8	15.25	280.00	TPO	Watt	1	0.00	9379.03	32	0	0
2	SPRINT (T-MOBILE)	RFS APXVAALL24_43-U-NA20	Panel	2100	LTE/AWS1	340	59.4	8	16.45	280.00	TPO	Watt	1	0.00	12363.97	32	0	0
2	SPRINT (T-MOBILE)	RFS APXVAALL24_43-U-NA20	Panel	600	LTE	340	62.8	8	13.35	100.00	TPO	Watt	1	0.00	2162.72	32	0	0
2	SPRINT (T-MOBILE)	RFS APXVAALL24_43-U-NA20	Panel	600	5G	340	62.8	8	13.35	100.00	TPO	Watt	1	0.00	2162.72	32	0	0
2	SPRINT (T-MOBILE)	RFS APXVAALL24_43-U-NA20	Panel	700	LTE	340	63.7	8	13.75	200.00	TPO	Watt	1	0.00	4742.74	32	0	0
3	SPRINT (T-MOBILE)	Ericsson AIR6449 (T-Mobile B41)	Panel	2500	LTE	165	12.5	2.8	22.65	160.00	TPO	Watt	1	0.00	29452.35	34	0	0
3	SPRINT (T-MOBILE)	Ericsson AIR6449 (T-Mobile B41)	Panel	2500	5G	165	12.5	2.8	22.65	160.00	TPO	Watt	1	0.00	29452.35	34	0	0
4	SPRINT (T-MOBILE)	RFS APXVAALL24_43-U-NA20	Panel	1900	LTE	165	64.9	8	15.25	280.00	TPO	Watt	1	0.00	9379.03	32	0	0
4	SPRINT (T-MOBILE)	RFS APXVAALL24_43-U-NA20	Panel	2100	LTE/AWS1	165	59.4	8	16.45	280.00	TPO	Watt	1	0.00	12363.97	32	0	0
4	SPRINT (T-MOBILE)	RFS APXVAALL24_43-U-NA20	Panel	600	LTE	165	62.8	8	13.35	100.00	TPO	Watt	1	0.00	2162.72	32	0	0
4	SPRINT (T-MOBILE)	RFS APXVAALL24_43-U-NA20	Panel	600	5G	165	62.8	8	13.35	100.00	TPO	Watt	1	0.00	2162.72	32	0	0
4	SPRINT (T-MOBILE)	RFS APXVAALL24_43-U-NA20	Panel	700	LTE	165	63.7	8	13.75	200.00	TPO	Watt	1	0.00	4742.74	32	0	0
5	VERIZON WIRELESS	Andrew DBXNH-6565A-VTM	Panel	1900		0	60.0	4.2	15.47	160.00	TPO	Watt	1	0.00	5637.93	48	0	0
5	VERIZON WIRELESS	Andrew DBXNH-6565A-VTM	Panel	2100		0	60.0	4.2	14.97	160.00	TPO	Watt	1	0.00	5024.81	48	0	0
6	VERIZON WIRELESS	Andrew DBXNH-6565A-VTM	Panel	1900		110	60.0	4.2	15.47	160.00	TPO	Watt	1	0.00	5637.93	48	0	0
6	VERIZON WIRELESS	Andrew DBXNH-6565A-VTM	Panel	2100		110	60.0	4.2	14.97	160.00	TPO	Watt	1	0.00	5024.81	48	0	0
7	VERIZON WIRELESS	Andrew DBXNH-6565A-VTM	Panel	751		0	68.0	4.2	11.27	160.00	TPO	Watt	1	0.00	2143.48	53	0	0
7	VERIZON WIRELESS	Andrew DBXNH-6565A-VTM	Panel	850		0	65.0	4.2	12.47	160.00	TPO	Watt	1	0.00	2825.66	53	0	0
8	VERIZON WIRELESS	Andrew DBXNH-6565A-VTM	Panel	751		110	68.0	4.2	11.27	160.00	TPO	Watt	1	0.00	2143.48	53	0	0
8	VERIZON WIRELESS	Andrew DBXNH-6565A-VTM	Panel	850		110	65.0	4.2	12.47	160.00	TPO	Watt	1	0.00	2825.66	53	0	0

Note: The Z reference indicates antenna height above ground level (AGL). ERP values provided by the client and used in the modeling may be greater than are currently deployed. For additional modeling information, refer to Appendix B.



5 Engineer Certification

The professional engineer whose seal appears on the cover of this document hereby certifies and affirms:

That I am registered as a Professional Engineer in the jurisdiction indicated in the professional engineering stamp on the cover of this document; and

That I, Michael A. McGuire, P.E., am currently and actively licensed to provide (in this state/jurisdiction as indicated within the professional electrical engineering seal on the cover of this document) professional electrical engineering services, as an employee of Hurricane Hill Development Company, PLLC, a duly authorized/registered engineering firm (in this state, as applicable) on behalf of Site Safe, LLC; and

That I am thoroughly familiar with the Rules and Regulations of the Federal Communications Commission (FCC) as well as the regulations of the Occupational Safety and Health Administration (OSHA), both in general and specifically as they apply to the FCC Guidelines for Human Exposure to Radio Frequency Electromagnetic Fields; and

That I have thoroughly reviewed this Site Compliance Report and believe it to be true and accurate to the best of my knowledge as assembled by and attested to by Sophie Thein.

January 20, 2023



Appendix A – Statement of Limiting Conditions

Sitesafe will not be responsible for matters of a legal nature that affect the site or property.

Due to the complexity of some wireless sites, Sitesafe performed this analysis and created this report utilizing best industry practices and due diligence. Sitesafe cannot be held accountable or responsible for anomalies or discrepancies due to actual site conditions (i.e., mislabeling of antennas or equipment, inaccessible cable runs, inaccessible antennas or equipment, etc.) or information or data supplied by Crown Castle, the site manager, or their affiliates, subcontractors or assigns.

Sitesafe has provided computer generated model(s) in this Site Compliance Report to show approximate dimensions of the site, and the model is included to assist the reader of the compliance report to visualize the site area, and to provide supporting documentation for Sitesafe's recommendations.

Sitesafe may note in the Site Compliance Report any adverse physical conditions, such as needed repairs, observed during the survey of the subject property or that Sitesafe became aware of during the normal research involved in performing this survey. Sitesafe will not be responsible for any such conditions that do exist or for any engineering or testing that might be required to discover whether such conditions exist. Because Sitesafe is not an expert in the field of mechanical engineering or building maintenance, the Site Compliance Report must not be considered a structural or physical engineering report.

Sitesafe obtained information used in this Site Compliance Report from sources that Sitesafe considers reliable and believes them to be true and correct. Sitesafe does not assume any responsibility for the accuracy of such items that were furnished by other parties. When conflicts in information occur between data provided by a second party and physical data collected by Sitesafe, the physical data will be used.



Appendix B – Assumptions and Definitions

General Model Assumptions

In this site compliance report, it is assumed that all antennas are operating at **full power at all times**. Software modeling was performed for all transmitting antennas located on the site. Sitesafe has further assumed a 100% duty cycle and maximum radiated power.

The site has been modeled with these assumptions to show the maximum RF energy density. Sitesafe believes this to be a *worst-case* analysis, based on best available data. Areas modeled to predict exposure greater than 100% of the applicable MPE level may not actually occur but are shown as a *worst-case* prediction that could be realized real time. Sitesafe believes these areas to be safe for entry by occupationally trained personnel utilizing appropriate personal protective equipment (in most cases, a personal monitor).

Thus, at any time, if power density measurements were made, we believe the real-time measurements would indicate levels below those depicted in the RF exposure diagram(s) in this report. By modeling in this way, Sitesafe has conservatively shown exclusion areas – areas that should not be entered without the use of a personal monitor, carriers reducing power, or performing real-time measurements to indicate real-time exposure levels.

Definitions

5% Rule – The rules adopted by the FCC specify that, in general, at multiple transmitter sites actions necessary to bring the area into compliance with the guidelines are the shared responsibility of all licensees whose transmitters produce field strengths or power density levels at the area in question in excess of 5% of the exposure limits. In other words, any wireless operator that contributes 5% or greater of the MPE limit in an area that is identified to be greater than 100% of the MPE limit is responsible for taking corrective actions to bring the site into compliance.

Compliance – The determination of whether a site complies with FCC standards with regards to Human Exposure to Radio Frequency Electromagnetic Fields from transmitting antennas.

Decibel (dB) – A unit for measuring power or strength of a signal.

Duty Cycle – The percent of pulse duration to the pulse period of a periodic pulse train. Also, may be a measure of the temporal transmission characteristic of an intermittently transmitting RF source such as a paging antenna by dividing average transmission duration by the average period for transmission. A duty cycle of 100% corresponds to continuous operation.

Effective (or Equivalent) Isotropic Radiated Power (EIRP) – The product of the power supplied to the antenna and the antenna gain in a given direction relative to an isotropic antenna.

Effective Radiated Power (ERP) – The product of the power supplied to the antenna and the antenna gain in a given direction relative to a half-wave dipole antenna.

Gain (of an antenna) – The ratio, usually expressed in decibels, of the power required at the input of a loss-free reference antenna to the power supplied to the input of the given antenna to produce, in a given direction, the same field strength or the same power density at the same distance. When not specified otherwise, the gain refers to the direction of maximum radiation. Gain may be considered for a specified polarization. Gain may be referenced to an isotropic antenna (dBi) or a half-wave dipole (dBd) antenna.

General Population/Uncontrolled Environment – Defined by the FCC as an area where RF exposure may occur to persons who are *unaware* of the potential for exposure and who have no control over their exposure. General Population is also referenced as General Public.

Generic Antenna – For the purposes of this report, the use of “Generic” as an antenna model means the antenna information was not provided and could not be obtained while on site. In the event of unknown information, Sitesafe will use its industry specific knowledge of antenna models to select a worst-case scenario antenna to model the site.

Isotropic Antenna – An antenna that is completely non-directional. In other words, an antenna that radiates energy equally in all directions.

Maximum Measurement – This measurement represents the single largest measurement recorded when performing a spatial average measurement.

Maximum Permissible Exposure (MPE) – The rms and peak electric and magnetic field strength, their squares, or the plane-wave equivalent power densities associated with these fields to which a person may be exposed without harmful effect and with acceptable safety factor.

Occupational/Controlled Environment – Defined by the FCC as an area where RF exposure may occur to persons who are **aware** of the potential for exposure as a condition of employment or specific activity and can exercise control over their exposure.

OET Bulletin 65 – Technical guideline developed by the FCC's Office of Engineering and Technology to determine the impact of RF exposure on humans. The guideline was published in August 1997.

OSHA (Occupational Safety and Health Administration) – Under the Occupational Safety and Health Act of 1970, employers are responsible for providing a safe and healthy workplace for their employees. OSHA's role is to promote the safety and health of America's working men and women by setting and enforcing standards; providing training, outreach and education; establishing partnerships; and encouraging continual process improvement in workplace safety and health. For more information, visit www.osha.gov.

Radio Frequency Exposure or Electromagnetic Fields – Electromagnetic waves that are propagated from antennas through space.

Spatial Average Measurement – A technique used to average a minimum of ten (10) measurements taken in a ten (10) second interval from zero (0) to six (6) feet. This measurement is intended to model the average energy a 6-foot tall human body will absorb while present in an electromagnetic field of energy.

Transmitter Power Output (TPO) – The radio frequency output power of a transmitter's final radio frequency stage as measured at the output terminal while connected to a load.

Appendix C – Rules & Regulations

Explanation of Applicable Rules and Regulations

The FCC has set forth guidelines in OET Bulletin 65 for human exposure to radio frequency electromagnetic fields. Specific regulations regarding this topic are listed in Part 1, Subpart I, of Title 47 in the Code of Federal Regulations. Currently, there are two different levels of MPE - General Public MPE and Occupational MPE. An individual classified as Occupational can be defined as an individual who has received appropriate RF training and meets the conditions outlined below. General Public is defined as anyone who does not meet the conditions of being Occupational. FCC and OSHA Rules and Regulations define compliance in terms of total exposure to total RF energy, regardless of location of or proximity to the sources of energy.

It is the responsibility of all licensees to ensure these guidelines are maintained at all times. It is the ongoing responsibility of all licensees composing the site to maintain ongoing compliance with the FCC Rules and Regulations. Individual licensees that contribute less than 5% MPE to any total area out of compliance are not responsible for corrective actions.

OSHA has adopted and enforces the FCC's exposure guidelines. A building owner or site manager can use this report as part of an overall RF Health and Safety Policy. It is important for building owners/site managers to identify areas in excess of the General Population MPE and ensure that only persons qualified as Occupational are granted access to those areas.

Occupational Environment Explained

The FCC definition of Occupational exposure limits apply to persons who:

- are exposed to RF energy as a consequence of their employment;
- have been made aware of the possibility of exposure; and
- can exercise control over their exposure.

OSHA guidelines go further to state that persons must complete RF Safety Awareness training and must be trained in the use of appropriate personal protective equipment.

In order to consider this site an Occupational Environment, the site must be controlled to prevent access by any individuals classified as the General Public. Compliance is also maintained when any non-occupational individuals (the General Public) are prevented from accessing areas indicated as Red or Yellow in the attached RF exposure diagram. In addition, a person must be aware of the RF environment into which they are entering. This can be accomplished by an RF Safety Awareness class, and by appropriate written documentation such as this Site Compliance Report.

All Crown Castle employees who require access to this site must complete RF Safety Awareness training and must be trained in the use of appropriate personal protective equipment.

Appendix D – General Safety Recommendations

The following are *general recommendations* appropriate for any site with accessible areas in excess of 100% General Public MPE. These recommendations are not specific to this site. These are safety recommendations appropriate for typical site management, building management, and other tenant operations.

1. All individuals needing access to the main site (or the area indicated to be in excess of General Public MPE) should wear a personal protective monitor (PPM), successfully complete proper RF Safety Awareness training, and have and be trained in the use of appropriate personal protective equipment.
2. All individuals needing access to the main site should be instructed to read and obey all posted placards and signs.
3. The site should be routinely inspected and this or similar report updated with the addition of any antennas or upon any changes to the RF environment including:
 - adding new antennas that may have been located on the site
 - removing of any existing antennas
 - changes in the radiating power or number of RF emitters
4. Post the appropriate **NOTICE**, **CAUTION**, or **WARNING** sign at the main site access point(s) and other locations as required. Note: Please refer to RF Exposure Diagrams in Section 3.1 to inform everyone who has access to this site that beyond posted signs there may be levels in excess of the limits prescribed by the FCC. In addition to RF Advisory Signage, a RF Guideline Signage is recommended to be posted at the main site access point(s). The signs below are examples of signs meeting FCC guidelines.



5. Ensure that the site door remains locked (or appropriately controlled) to deny access to the general public if deemed as policy by the building/site owner.
6. For a General Public environment the five color levels identified in this analysis can be interpreted in the following manner:
 - Gray represents areas predicted to be at 5% or less of the General Public MPE limits. *The General Public can access these areas with no restrictions.*

- Green represents areas predicted to be between 5% and 100% of the General Public MPE limits. *The General Public can access these areas with no restrictions.*
- Blue represents areas predicted to be between 100% and 500% of the General Public MPE limits. *The General Public should be restricted from accessing these areas.*
- Yellow represents areas predicted to be between 500% and 5000% of the General Public MPE limits. *The General Public should be restricted from accessing these areas.*
- Red represents areas predicted to be greater than 5000% of the General Public MPE limits. *The General Public should be restricted from accessing these areas.*

7. For an Occupational environment the five color levels identified in this analysis can be interpreted in the following manner:

- Gray represents areas predicted to be at 1% or less of the Occupational MPE limits. *Workers can access these areas with no restrictions.*
- Green represents areas predicted to be between 1% and 20% of the Occupational MPE limits. *Workers can access these areas with no restrictions.*
- Blue represents areas predicted to be between 20% and 100% of the Occupational MPE limits. Workers can access these areas assuming they have basic understanding of EME awareness and RF safety procedures and understand how to limit their exposure.
- Yellow represents areas predicted to be between 100% and 1000% of the Occupational MPE limits. Workers can access these areas assuming they have basic understanding of EME awareness and RF safety procedures and understand how to limit their exposure. Transmitter power reduction and/or time-averaging may be required.
- Red represents areas predicted to be greater than 1000% of the Occupational MPE limits. These areas are not safe for workers to be in for prolonged periods of time. Special procedures must be adhered to, such as lockout/tagout or transmitter power reduction, to minimize worker exposure to EME.

8. Use of a Personal Protective Monitor (PPM): When working around antennas, Sitesafe strongly recommends the use of a PPM. Wearing a PPM will properly forewarn the individual prior to entering an RF exposure area.

Keep a copy of this report available for all persons who must access the site. They should read this report and be aware of the potential hazards with regards to RF and MPE limits.

Additional Information

Additional RF information is available at the following sites:

<https://www.fcc.gov/general/radio-frequency-safety-0>

<https://www.fcc.gov/engineering-technology/electromagnetic-compatibility-division/radio-frequency-safety/faq/rf-safety>

OSHA has additional information available at:

<https://www.osha.gov/SLTC/radiofrequencyradiation/index.html>

Appendix E – Regulatory Basis

FCC Rules and Regulations

In 1996, the Federal Communications Commission (FCC) adopted regulations for evaluating the effects of RF exposure in 47 CFR § 1.1307 and 1.1310. The guideline from the FCC Office of Engineering and Technology is Bulletin 65 (“OET Bulletin 65”), *Evaluating Compliance with FCC Guidelines for Human Exposure to Radio Frequency Electromagnetic Fields*, Edition 97-01, published August 1997. Since 1996 the FCC periodically reviews these rules and regulations as per their congressional mandate.

FCC regulations define two separate tiers of exposure limits: Occupational or “Controlled environment” and General Public or “Uncontrolled environment”. The General Public limits are generally five times more conservative or restrictive than the Occupational limits. The General Public limits apply to *accessible* areas where workers or the general public may be exposed to Radio Frequency (RF) electromagnetic fields.

Occupational or Controlled limits apply in situations in which persons are exposed as a consequence of their employment and where those persons exposed have been made fully aware of the potential for exposure and can exercise control over their exposure.

An area is considered a Controlled environment when access is limited to these aware personnel. Typical criteria are restricted access (i.e. locked or alarmed doors, barriers, etc.) to the areas where antennas are located coupled with proper RF hazard signage. A site with Controlled environments is evaluated with Occupational limits.

All other areas are considered Uncontrolled environments. If a site has no access controls or no RF hazard signage it is evaluated with General Public limits.

The theoretical modeling of the RF electromagnetic fields has been performed in accordance with OET Bulletin 65. The Maximum Permissible Exposure (MPE) limits utilized in this analysis are outlined in the following diagram:

FCC Limits for Maximum Permissible Exposure (MPE)
Plane-wave Equivalent Power Density

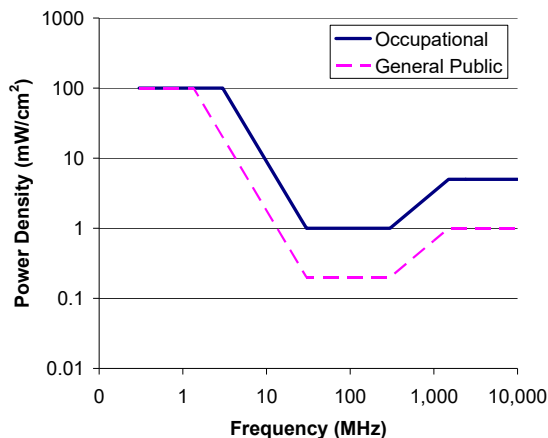

Limits for Occupational/Controlled Exposure (MPE)

Frequency Range (MHz)	Electric Field Strength (E) (V/m)	Magnetic Field Strength (H) (A/m)	Power Density (S) (mW/cm ²)	Averaging Time (minutes)
0.3-3.0	614	1.63	(100)*	6
3.0-30	1842/f	4.89/f	(900/f ²)*	6
30-300	61.4	0.163	1.0	6
300-1500	--	--	f/300	6
1500-100,000	--	--	5	6

Limits for General Population/Uncontrolled Exposure (MPE)

Frequency Range (MHz)	Electric Field Strength (E) (V/m)	Magnetic Field Strength (H) (A/m)	Power Density (S) (mW/cm ²)	Averaging Time (minutes)
0.3-1.34	614	1.63	(100)*	30
1.34-30	824/f	2.19/f	(180/f ²)*	30
30-300	27.5	0.073	0.2	30
300-1500	--	--	f/1500	30
1500-100,000	--	--	1.0	30

f = frequency in MHz *Plane-wave equivalent power density

Appendix F – Safety Plan and Procedures

The following items are general safety recommendations that should be administered on a site by site basis as needed by the carrier.

General Maintenance Work: Any maintenance personnel required to work immediately in front of antennas and / or in areas indicated as above 100% of the Occupational MPE limits should coordinate with the wireless operators to disable transmitters during their work activities.

Training and Qualification Verification: All personnel accessing areas indicated as exceeding the General Population MPE limits should have a basic understanding of EME awareness and RF Safety procedures when working around transmitting antennas. Awareness training increases a worker's understanding to potential RF exposure scenarios. Awareness can be achieved in a number of ways (e.g. videos, formal classroom lecture or internet-based courses).

Physical Access Control: Access restrictions to transmitting antennas locations is the primary element in a site safety plan. Examples of access restrictions are as follows:

- Locked door or gate
- Alarmed door
- Locked ladder access
- Restrictive Barrier at antenna (e.g. Chain link with posted RF Sign)

RF Signage: Everyone should obey all posted signs at all times. RF signs play an important role in properly warning a worker prior to entering into a potential RF Exposure area.

Assume all antennas are active: Due to the nature of telecommunications transmissions, an antenna transmits intermittently. Always assume an antenna is transmitting. Never stop in front of an antenna. If you have to pass by an antenna, move through as quickly and safely as possible thereby reducing any exposure to a minimum.

Site RF Exposure Diagram(s): Section 3 of this report contains RF Diagram(s) that outline various theoretical Maximum Permissible Exposure (MPE) areas at the site. The modeling is a worst-case scenario assuming a duty cycle of 100% for each transmitting antenna at full power. This analysis is based on one of two access control criteria: General Public criteria means the access to the site is uncontrolled and anyone can gain access. Occupational criteria means the access is restricted and only properly trained individuals can gain access to the antenna locations.



COUNTY OF SAN MATEO - PLANNING AND BUILDING DEPARTMENT

ATTACHMENT E

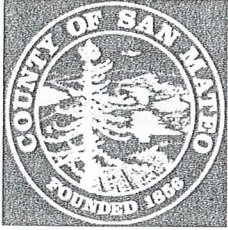

County of San Mateo

Planning & Building Department

455 County Center, 2nd Floor
Redwood City, California 94063
650/363-4161 Fax: 650/363-4849

Mail Drop PLN122
plngbldg@smcgov.org
www.co.sanmateo.ca.us/planning

October 2, 2012

Clarence Chavis
Ridge Communications, Inc.
12667 Alcosta Blvd., Suite 175
San Ramon, CA 94583

PROJECT FILE

Dear Mr. Chavis:

Subject: **FINAL LETTER OF DECISION**
File Number: PLN2011-00312
Location: 21960 Cabrillo Highway, San Gregorio
APN: 066-330-160

On September 26, 2012 the San Mateo County Planning Commission considered a Planned Agricultural Permit and Use Permit, pursuant to Sections 6350, 6513, and 6405 of the San Mateo County Zoning Regulations, a Grading Permit pursuant to Section 8600 of the County Ordinance Code, and an Architectural Review Permit pursuant to Section 261 of the State Streets and Highways Code, and certification of a Mitigated Negative Declaration to co-locate a new cellular communications facility at an existing Sprint site, located northeast of the intersection of Tunitas Creek Road and Cabrillo Highway, at 21960 Cabrillo Highway in the unincorporated San Gregorio area of San Mateo County. The project is located within the Cabrillo Highway State Scenic Corridor. The Use Permit includes a height limit exception.

Based on information provided by staff and evidence presented at the hearing, the Planning Commission approved the project by adopting the required findings and conditions of approval as identified in Attachment A, including the addition of condition number 21 and minor amendments to the conditions noted with an asterisk (*).

Any interested party aggrieved by the determination of the Planning Commission has the right of appeal to the Board of Supervisors within ten (10) business days from such date of determination. The appeal period for this matter will end at **5:00 p.m. on October 11, 2012.**

Keith and Cynthia Waddell
October 2, 2012
Page 2

If you have questions regarding this matter, please contact Summer Burlison, Project Planner, at 650/363-1815 or Email: sburlisson@smcgov.org .

Sincerely,



Rosario Fernandez
Planning Commission Secretary
Pcd0926w_rf (Waddell)

Enclosure: San Mateo County Survey - An online version of our Customer Survey is also available at: <http://www.co.sanmateo.ca.us/planning/survey>

cc: Keith and Cynthia Waddell, Property Owners
Department of Public Works
Building Inspection Section
Geotechnical Section
CALFIRE
California Coastal Commission
CALTRANS
California Department of Fish and Game
County Assessor

County of San Mateo
Planning and Building Department

FINDINGS AND CONDITIONS OF APPROVAL

Permit or Project File Number: PLN 2011-00312

Hearing Date: September 26, 2012

Prepared By: Summer Burlison, Project Planner

Adopted By: Planning Commission

FINDINGS

Regarding the Mitigated Negative Declaration, Found:

1. That the Mitigated Negative Declaration is complete, correct and adequate, and prepared in accordance with the California Environmental Quality Act and applicable State and County Guidelines.
2. That, on the basis of the Initial Study, comments received hereto, and testimony presented and considered at the public hearing, there is no substantial evidence that the project will have a significant effect on the environment.
3. That the Mitigated Negative Declaration reflects the independent judgment of San Mateo County.
4. That the mitigation measures in the Negative Declaration and agreed to by the owner and placed as conditions on the project have been incorporated into the Mitigation Monitoring and Reporting Plan in conformance with the California Public Resources Code Section 21081.6.

For the Planned Agricultural Permit, Found:

5. That the proposed project, as described in the application and accompanying materials, complies with all applicable criteria for the issuance of a Planned Agricultural District Permit contained in Section 6355 of the County Zoning Regulations, including:

General Criteria

- a. That the encroachment of all development upon land which is suitable for agricultural uses and other lands is minimized. The parcel is composed of non-prime soils and the project area is already developed with a cellular facility. Remaining undeveloped areas of the parcel are used for ongoing cattle grazing in compliance with the parcel's Williamson Act contract and agricultural conservation easement. The proposed co-location will require minimal new ground disturbance and is not expected to impact existing or potential agricultural use of the land.

- b. That development permitted on the site is clustered, as the project involves co-locating a new cellular communications facility to the existing Sprint cellular facility located on the parcel.
- c. That the project conforms to the Development Review Criteria contained in Chapter 20A.2 of the San Mateo County Ordinance Code, including Section 6324.1 (*Environmental Quality Criteria*), Section 6324.2 (*Site Design Criteria*), Section 6324.3 (*Utilities*), Section 6324.4 (*Water Resources Criteria*), Section 6324.5 (*Cultural Resources Criteria*), Section 6324.6 (*Hazards to Public Safety Criteria*), Section 6325.1 (*Primary Scenic Resources Areas Criteria*), Section 6325.3 (*Primary Agricultural Resources Area Criteria*), and Section 6325.4 (*Primary Water Resources Area Criteria*), as the project includes minimal grading, vegetation, and tree removal, and will utilize existing developed areas. Erosion and sediment control measures will be implemented around the project site and disturbed areas will be reseeded with native perennial grasses. The monopole and antennas will be painted to blend in with the skyline to minimize visual impact, and all new utility lines will be placed underground.

Criteria for the Conversion of Lands Suitable for Agriculture and Other Land

- a. That all agriculturally unsuitable lands on the parcel have been developed or determined to be undevelopable. Aside from permitted residential development in the northeast portion of the property, the remaining areas of the parcel support ongoing cattle grazing. Given the low intensity of development associated with cellular facilities, any impact to existing or potential agricultural use of the area is minimal.
- b. That continued or renewed agricultural use of the soils is not capable of being accomplished in a successful manner within a reasonable period of time, taking into account economic, environmental, social, and technological factors. The project parcel contains no prime soils. The project will not adversely impact agricultural use of the property as Verizon proposes to co-locate with the existing Sprint cellular facility, thereby clustering cellular development and minimizing any disturbance to undisturbed agricultural land.
- c. That clearly defined buffer areas are developed between agricultural and non-agricultural uses. All existing cellular facility equipment is located within a fenced equipment area, including the monopole. The proposed project will include replacing the monopole in the same location, within the fenced equipment area, and constructing an elevated equipment platform above Sprint's existing fenced area for Verizon's proposed equipment.
- d. That the productivity of any adjacent agricultural lands is not diminished, including the ability of the land to sustain dry farming or animal grazing. The project area is already developed with a cellular facility, including an existing access road from Cabrillo Highway to the project area. The project will utilize the footprint of existing

cellular facility development with minimal ground disturbance for access road improvements as required by the Fire Department. The proposed cellular facility co-location is not expected to diminish or impair agricultural use of the area.

- e. That public services and facility expansions and permitted uses do not impair agricultural viability, either through increased assessment costs or degraded air and water quality. The project area was converted from Lands Suitable for Agriculture in 2001 upon the approval and construction of a Sprint cellular facility at the proposed project location. Furthermore, dust, erosion and sediment control measures are included as conditions of approval to ensure that any temporary impacts to air and water quality are minimized.

For the Use Permit, Found:

6. That the establishment, maintenance and/or conducting of the use will not, under the circumstances of the particular case, be detrimental to the public welfare or injurious to property or improvements in said neighborhood, since the proposed co-location will not exceed FCC public exposure limits, individually or cumulatively. The site will continue to require only minimal routine service visits of the otherwise non-staffed facility; therefore, co-location is not expected to be detrimental to the public welfare, or injurious to property or improvements in the neighborhood.
7. That the project is necessary for the public health, safety, convenience or welfare as the co-location will enhance and increase the capacity and network coverage to the surrounding area to accommodate the growing demand from private citizens and public agencies, including emergency services.
8. That the Use Permit to exceed the height limitations of the zoning district is necessary in order to accommodate co-location with Sprint's existing antennas and to ensure maximum performance and service coverage in the area. The benefits provided by the cellular service, for both general customers and for emergency services, outweigh any impacts caused by the over-height antennas and monopole.

For the Grading Permit, Found:

9. That the granting of the permit will not have a significant adverse effect on the environment. Staff has prepared an Initial Study, pursuant to California Environmental Quality Act (CEQA) regulations, and determined that the project, if undertaken with appropriate mitigation measures, would not have a significant adverse impact on the environment and that the Planning Commission agrees with staff's determination for the reasons stated in the staff report. The Negative Declaration's mitigation measures have been incorporated into the recommended conditions of approval to ensure that the project will have no adverse impacts to the environment.
10. That the project conforms to the criteria of Chapter 8, Division VII, of the San Mateo County Ordinance Code, including the standards referenced in Section 8605. The project, as proposed and conditioned, conforms to standards in the Grading Ordinance,

including those regarding an erosion and sediment control plan, dust control plan, fire safety, and the timing of grading activity.

11. That the project is consistent with the San Mateo County General Plan. The project has been reviewed against the applicable policies of the General Plan, including the Vegetative, Water, Fish and Wildlife Resources, Soil Resources, Visual Quality, Historical and Archaeological Resources, Rural Land Use, and Geotechnical Hazards Policies, and found, as proposed and conditioned, to be consistent with its goals and objectives.

For the Architectural Review Permit, Found:

12. That the proposed project is in compliance with the architectural design standards for the Cabrillo Highway State Scenic Corridor as regulated by the policies and criteria within the General Plan Visual Quality Policies and Planned Agricultural District General Criteria. As discussed in the staff report, visual impacts from Cabrillo Highway will be minimized by existing vegetation and topography and use of an appropriate paint color to blend the monopole and antennas in with the skyline. Also, all new utility lines will be placed underground.

CONDITIONS OF APPROVAL

Current Planning Section

1. The approval applies only to the proposal, documents, and plans described in this report and submitted and approved by the Planning Commission on September 26, 2012. Minor modifications to the project may be approved by the Community Development Director if they are consistent with the intent of, and in substantial conformance with, this approval.
2. The Planned Agricultural Permit, Use Permit, Grading Permit, and Architectural Permit approvals shall become valid when a Coastal Development Permit Amendment has been issued by the California Coastal Commission for the subject project, and shall be valid for ten (10) years. Renewal of this permit shall be applied for six months prior to expiration, to the Planning and Building Department, and shall be accompanied by the renewal application and fees applicable at that time.
3. Any change in use or intensity not already approved shall require an amendment to the use permit. Amendment to this use permit requires an application for amendment, payment of applicable fees, and consideration at a public hearing.
4. The applicant shall obtain a building permit and install the facility in accordance with the approved plans and conditions of approval. No site disturbance shall occur, including any grading or tree removal, until the grading permit (issued as the "hard card" with all necessary information filled out and signatures obtained) has been issued, either concurrently or prior to issuance of the building permit.
5. The site is considered a Construction Stormwater Regulated Site. Any grading and/or ground disturbance activities conducted during the wet weather season (October 1 to

- April 30) will require monthly erosion and sediment control inspections by the Building Inspection Section.
6. Any future modifications to the approved facility or amendments to the use permit for this facility may require a Coastal Development Permit (Amendment) from the California Coastal Commission.
 - *7. If a less visually obtrusive/reduced antenna technology becomes available for use during the life of this project, which would, at a minimum, provide equivalent service and coverage as the current approved antenna technology, then the applicant shall present a redesign incorporating this technology into the project for review by the Community Development Director and any parties that have expressed an interest. This installation shall be removed in its entirety at that time when this technology becomes obsolete or this facility is no longer needed.
 8. The applicant shall maintain all necessary licenses and registrations from the Federal Communications Commission (FCC) and any other applicable regulatory bodies for the operation of the subject facility at this site. The applicant shall supply the Planning Department with evidence of such licenses and registrations. If any required license is ever revoked, the applicant shall inform the Planning Department of the revocation within ten (10) days of receiving notice of such revocation.
 9. The applicant shall not enter into a contract with the landowner or lessee which reserves for one company exclusive use of the tower structure or the site for telecommunication facilities.
 10. This facility and all equipment associated with it shall be removed in its entirety by the applicant within ninety (90) days if the FCC license and registration are revoked or if the facility is abandoned or no longer needed. The owner and/or operator of the facility shall notify the Planning Department upon abandonment of the facility.
 11. There shall be no external lighting associated with this use. Wireless telecommunication facilities shall not be lighted or marked unless required by the FCC or Federal Aviation Administration (FAA).
 12. All grading and construction activities associated with the proposed project shall be limited to 7:00 a.m. to 6:00 p.m., Monday through Friday, and 9:00 a.m. to 5:00 p.m. on Saturday. Construction activities will be prohibited on Sunday and any nationally observed holiday. Noise levels produced by construction activities shall not exceed 80-dBA at any one moment.
 13. This approved installation is to be dismantled and removed in its entirety from the property at that time when this technology becomes obsolete or this facility is no longer needed.
 - *14. Prior to the issuance of a building permit, the applicant shall submit color samples for the monopole, antennas and associated equipment. The pole, antennas and all associated

facility equipment shall be painted a non-reflective grey color to blend in with the skyline. Paint colors shall be subject to review and approval by the Community Development Director. The applicant shall submit photos to the Current Planning Section for color verification after the applicant has painted the monopole, antennas and equipment the approved color(s), but before a final building inspection is scheduled.

15. Any necessary utilities leading to, or associated with, the facility shall be placed underground.
16. This approval allows for the removal of eight (8) pine trees (six 6", one 8", and one 15" diameter). These trees shall be identified for removal on the building permit plans. Removal of any additional trees shall be subject to the review and approval by the Community Development Director, and may require an amendment to the Architectural Review and Planned Agricultural District Permits.
17. Tree protection measures shall be implemented prior to the beginning of any grading or construction activities and shall be maintained throughout the duration of the project to avoid damage to existing trees. At a minimum the following tree protection measures shall be implemented for any trees within, or adjacent to construction areas:

The applicant shall establish and maintain tree protection zones which shall be delineated using 4-ft. tall orange plastic fencing, supported by poles, pounded into the ground, located as close to the tree driplines as possible, while still allowing room for construction to safely continue. The applicant shall maintain tree protection zones free of equipment and material storage and shall not clean any equipment within these areas. Should any large roots or large masses of roots need to be cut, the roots shall be inspected by a certified arborist prior to cutting. Any root cutting shall be monitored by an arborist and documented.
18. The engineer who prepared the approved grading plans shall be responsible for the inspection and certification of the grading as required by Section 8606.2 of the Grading Ordinance. The engineer's responsibilities shall include those relating to non-compliance detailed in Section 8606.5 of the Grading Ordinance.
19. Prior to the final building construction inspection, the applicant shall demonstrate that the equipment area and antennas are accurately labeled with the name of the carrier having ownership.
20. The applicant shall submit the following to the Current Planning Section: Within four (4) working days of the final approval date of this permit, the applicant shall pay an environmental filing fee of \$2,101.50, as required under Fish and Game Code Section 711.4, plus a \$50.00 recording fee. Thus, the applicant shall submit a check in the total amount of \$2,151.50, made payable to San Mateo County, to the project planner to file with the Notice of Determination.
21. Tree replacement is required at a 1:1 ratio for the trees approved for removal (identified in condition of approval number 16), with native and indigenous tree species, using a

minimum 5-gallon sized stock. Prior to issuance of a building permit, the applicant shall submit a tree replacement plan that identifies the size, species, and location of the proposed replacement trees for review and approval. The applicant shall submit photos to the Current Planning Section verifying the approved tree plantings before a final building inspection is scheduled.

Mitigation Measures from the Mitigated Negative Declaration (No. 22 - 34)

22. The County's Planned Agricultural Permit, Use Permit, Grading Permit, and Architectural Review Permit approval shall not be valid until a Coastal Development Permit Amendment has been issued by the California Coastal Commission. Prior to the issuance of a building permit, the applicant shall submit a copy of the issued Coastal Development Permit Amendment and any applicable recorded agricultural conservation easement amendment to the Current Planning Section. The building permit plans shall incorporate any additional conditions adopted by the California Coastal Commission under the Coastal Development Permit Amendment.
23. All ground disturbed areas shall be reseeded with native perennial grasses that are characteristic of coastal terrace prairie, including, but not limited to, oatgrass and purple needlegrass.
24. Prior to beginning any construction activities, the applicant shall implement the approved Erosion and Sediment Control Plan, which shall be maintained throughout the duration of the project. Erosion control measure deficiencies, as they occur, shall be immediately corrected. The goal is to prevent sediment and other pollutants from leaving the project site and to protect all exposed earth surfaces from erosive forces. Said plan shall adhere to the San Mateo Countywide Stormwater Pollution Prevention Program "General Construction and Site Supervision Guidelines," including:
 - a. Stabilizing all denuded areas and maintaining erosion control measures continuously between October 1 and April 30 and as needed year round to maintain effective stormwater management. Stabilizing shall include both proactive measures, such as the placement of hay bales or coir netting, and passive measures, such as revegetating disturbed areas with plants propagated from seed collected in the immediate area. Use of erosion control matting shall be limited to larger size mesh (0.75" x 1.5"), single layer type mats to reduce interference with any potential snake movement in the area.
 - b. Storing, handling, and disposing of construction materials and wastes properly, so as to prevent their contact with stormwater.
 - c. Controlling and preventing the discharge of all potential pollutants, including pavement cutting wastes, paints, concrete, petroleum products, chemicals, wash water or sediments, and non-stormwater discharges to storm drains and watercourses.

- d. Using sediment controls or filtration to remove sediment when dewatering the site and obtaining all necessary permits.
 - e. Avoiding cleaning, fueling, or maintaining vehicles on-site, except in a designated area where wash water is contained and treated.
 - f. Delineating with field markers clearing limits, easements, setbacks, sensitive or critical areas, buffer zones, trees and drainage courses.
 - g. Protecting adjacent properties and undisturbed areas from construction impacts using vegetative buffer strips, sediment barriers or filters, dikes, mulching, or other measures as appropriate.
 - h. Performing clearing and earth-moving activities only during dry weather.
 - i. Limiting and timing applications of pesticides and fertilizers to prevent polluted runoff.
 - j. Limiting construction access routes and stabilizing designated access points.
 - k. Avoiding tracking dirt or other materials off-site; cleaning off-site paved areas and sidewalks using dry sweeping methods.
 - l. The contractor shall train and provide instructions to all employees and subcontractors regarding the construction Best Management Practices, including, but not limited to, those listed above.
 - m. Additional Best Management Practices in addition to those shown on the plans may be required by the Building Inspector to maintain effective stormwater management during construction activities and for post-construction site stabilization. Any water leaving the site shall be clear and running slowly at all times.
25. It shall be the responsibility of the engineer of record to regularly inspect the erosion control measures for the duration of all grading activities, especially after major storm events, and determine that they are functioning as designed and that proper maintenance is being performed. Deficiencies shall be immediately corrected, as determined by and implemented under the observation of the engineer of record.
26. The grading permit hard card will only be issued concurrently with the building permit.
27. No grading shall be allowed during the winter season (October 1 to April 30) to avoid potential soil erosion unless approved, in writing, by the Community Development Director. The applicant shall submit a letter to the Current Planning Section, at least, two (2) weeks prior to commencement of grading stating the date when grading will begin.
28. Prior to the beginning of any construction related activities, the applicant shall have a qualified biologist conduct a pre-construction survey of the project area for California red-

legged frog and San Francisco garter snake. If California red-legged frog or San Francisco garter snake species are detected, the U.S. Fish and Wildlife Service shall be contacted on how to proceed.

29. Prior to the beginning of any construction related activities, the applicant shall have a qualified biologist brief construction workers on identifying California red-legged frog and San Francisco garter snake.
30. The provision of the San Mateo County Grading Ordinance shall govern all grading on and adjacent to this site. Per San Mateo County Ordinance Section 8605.5, all equipment used in grading operations shall meet spark arrester and firefighting tool requirements, as specified in the California Public Resources Code.
31. All grading shall be according to approved plans that are prepared by, signed by, and dated by, a registered civil engineer. Any revisions to the approved plans shall be prepared and signed by the engineer, and shall be submitted to the Current Planning Section for concurrence "prior" to commencing any work pursuant to any proposed revision.
32. Prior to any grading or construction activities, the applicant shall implement and maintain throughout the duration of the project, the following minimum dust control measures:
 - a. Water all construction and grading areas at least twice daily.
 - b. Cover all trucks hauling soil, sand, and other loose materials or require all trucks to maintain at least 2 ft. of freeboard.
 - c. Water or cover stockpiles of debris, soil, sand, or other materials that can be blown by the wind.
33. The applicant is responsible for ensuring that all contractors are aware of all stormwater quality measures and implement such measures. Failure to comply with construction Best Management Practices (BMPs) will result in the issuance of correction notices, citations or a project stop order.
34. If during any site activities associated with the project any archaeological evidence is uncovered or encountered, all excavation within 30 ft. shall be halted long enough to call in a qualified archaeologist to assess the situation and propose appropriate mitigation measures. In addition, the Current Planning Section shall be notified of such findings, and no additional work shall be done on-site until the archaeologist has recommended appropriate measures, and those measures have been approved by the Current Planning Section.

Building Inspection Section

35. The applicant shall apply for and obtain a building permit prior to any construction activity related associated with this project approval.

Department of Public Works

36. The applicant shall coordinate with Caltrans for an encroachment permit for any work within the state right-of-way.
37. The applicant shall submit, for review by the Public Works Department and the appropriate Fire District, a Plan and Profile of both the existing and the proposed access from the nearest "publicly" maintained roadway to the proposed project site; County standards for road construction shall be used.

San Mateo County Fire Department

38. Portable fire extinguishers with a minimum rating of 2A-10BC are required to be placed throughout the project. Contact a licensed/certified fire extinguisher company for proper placement of the required extinguishers.
39. Fire Department access shall be to within 150 ft. of all exterior portions of the facility and all portions of the exterior walls of the first story of the buildings as measured by an approved access route around the exterior of the building or facility. Access shall be 12 ft. wide with an approved turnout near the halfway point, all weather surface, and able to support a fire apparatus weighing 75,000 lbs. Where a fire hydrant is located in the access, a minimum of 26 ft. is required for a minimum of 20 ft. on each side of the hydrant. This access shall be provided from a publicly maintained road to the property. Grades over 15% shall be paved and no grade shall be over 20%. When gravel roads are used, it shall be Class 2 base or equivalent compacted to 95%. Gravel road access shall be certified by an engineer as to the compaction and weight it will support.
40. All dead end roadways shall be terminated by a turnaround bulb of not less than 96 ft. in diameter. Alternates such as a hammerhead "T" may be approved by the Fire Marshal.
41. Because of limited access into the property, the San Mateo County Fire Department is requiring the installation of a Knox Box, Knox Key Switch, or Knox Padlock to allow rapid response of emergency vehicles onto your property in case of a fire or medical emergency. For an application or further information please contact the San Mateo County Fire Marshal's Office at 650/573-3846.
42. All structures that have a street address shall have the number of that address on the building, mailbox, or other type of sign at the driveway entrance in such a manner that the number is easily and clearly visible from either direction of travel from the street. Address numbers shall be at least 6 ft. above the finished surface of the driveway. An address sign shall be placed at each break of the road where deemed applicable by the San Mateo County Fire Department. Numerals shall be contrasting in color to their background and shall be no less than 6 inches in height, and have a minimum 1/2-inch stroke.

43. A Cabrillo Highway address shall be posted at the driveway entrance, consistent with addressing along Cabrillo Highway (as determined and issued by the Building Inspection Section).

Geotechnical Section

44. For final approval of the grading permit, the applicant shall ensure the performance of the following activities, within thirty (30) days of the completion of grading:
 - a. The engineer shall submit written certification to the Department of Public Works and the Current Planning Section that all grading, lot drainage, and drainage facilities have been completed in conformance with the approved plans, as conditioned, and the Grading Ordinance.
 - b. The geotechnical consultant shall submit to the Building Inspection Section's Geotechnical Engineer and the Current Planning Section a signed Section II of the Geotechnical Consultant Approval form indicating they have observed all grading activities and that the work conformed to the approved plans.

Please include the Geotechnical File Number, 17D-6, in all correspondence with the Geotechnical Section of the Planning and Building Department.